



AT COMMANDS INTERFACE GUIDE

wavecom[®]

wavecom  confidential ©

This document is the sole and exclusive property of WAVECOM. Not to be distributed or divulged without prior written agreement. Ce document est la propriété exclusive de WAVECOM. Il ne peut être communiqué ou divulgué à des tiers sans son autorisation préalable.



AT COMMANDS INTERFACE GUIDE

atVersion: 006

Date: September, 04th 2002

Reference: WM_SW_OAT_IFS_001

| Level | Date | History of the evolution |
|---------|----------|--|
| 001/9.1 | 01/11/01 | Full revision |
| 002 | 27/02/02 | +VGR correction |
| | 19/12/01 | Add <ring tone level> parameter to +WSST Format modification |
| | 28/01/02 | Update +Wopen to erase the objects flash of Open-AT embedded application |
| | 29/01/02 | New commands : +WBM (Serial bus management) +WBR (Serial bus read) +WBW (Serial bus write) |
| | 18/02/02 | Modifications on Gpio and Bus commands +CMER always allowed |
| | 22/02/02 | Addendum about Test SIM card (with MCC=001 & MNC=01) for +CLCK & +WLCK commands. |
| | | Max read/write length is 256 bytes for +WBW & +WBR commands. |
| 003 | 27/02/02 | New commands: +WATH(hang-up precising release cause) +WLOC (location) add wind level: level 11 for checksum of phonebooks level 12 for interrupt new fetures: "loca" and "interrupt" |
| | 02/04/02 | +ATO correction |
| 004 | 05/04/02 | +WBW / +WBR parameters modification |
| 005 | 03/05/02 | GPRS commands New commands : Write IMEI +WIMEI +CPLS (Selection of preferred PLMN list) Update : +CPOL +CMER +CPLW +CGSN +WFM |
| | 25/06/02 | Update description of power down mode, +WCDP, +CRMP, and description of autobauding feature |
| | 26/06/02 | Update +ECHO command |
| | 28/06/02 | +VGT correction |
| | 01/07/02 | Add CME ERROR: 27, +ICF correction, +VIP correction, +SPEAKER correction |
| | 25/07/02 | Update +CCFC command Change value for class parameter |
| | 06/08/02 | Update +VGT command |
| 006 | 19/08/02 | Correct DOPT description Add details for AT&F Correct AT%C default value in table 19.10 |
| | 28/08/02 | Update Table 19.10 for +CPHS command. ,0 instead 0 in Default Values |
| | 28/08/02 | Add many 'OK' that were forgotten in AT responses Correct AT+DR=? response |
| | 29/08/02 | Add optional lac parameter for AT+WOPN |

Contents

| | | |
|----------|--|-----------|
| 1 | Introduction | 13 |
| 1.1 | Scope of this document..... | 13 |
| 1.2 | Related documents..... | 13 |
| 1.3 | ETSI secretariat | 13 |
| 1.4 | Definitions..... | 14 |
| | | |
| 2 | AT commands features..... | 15 |
| 2.1 | Wavecom line settings | 15 |
| 2.2 | Command line..... | 15 |
| 2.3 | Information responses and result codes | 15 |
| | | |
| 3 | General behaviors | 16 |
| 3.1 | SIM Insertion, SIM Removal..... | 16 |
| 3.2 | Background initialization | 16 |
| | | |
| 4 | General commands..... | 17 |
| 4.1 | Manufacturer identification +CGMI | 17 |
| 4.2 | Request model identification +CGMM..... | 17 |
| 4.3 | Request revision identification +CGMR | 17 |
| 4.4 | Product Serial Number +CGSN..... | 18 |
| 4.5 | Select TE character set +CSCS..... | 18 |
| 4.6 | Wavecom Phonebook Character Set +WPCS..... | 19 |
| 4.7 | Request IMSI +CIMI..... | 19 |
| 4.8 | Card Identification +CCID..... | 20 |
| 4.9 | Capabilities list +GCAP..... | 20 |
| 4.10 | Repeat last command A/..... | 21 |
| 4.11 | Power off +CPOF..... | 21 |

| | | |
|----------|---|-----------|
| 4.12 | Set phone functionality +CFUN | 21 |
| 4.13 | Phone activity status +CPAS | 22 |
| 4.14 | Report Mobile Equipment errors +CMEE | 23 |
| 4.15 | Keypad control +CKPD | 23 |
| 4.16 | Clock Management +CCLK | 24 |
| 4.17 | Alarm Management +CALA..... | 24 |
| 4.18 | Ring Melody Playback +CRMP | 25 |
| 4.19 | Ringer Sound Level +CRSL | 27 |
| 5 | Call Control commands | 28 |
| 5.1 | Dial command D..... | 28 |
| 5.2 | Hang-Up command H..... | 30 |
| 5.3 | Answer a call A..... | 30 |
| 5.4 | Remote disconnection | 30 |
| 5.5 | Extended error report +CEER..... | 31 |
| 5.6 | DTMF signals +VTD, +VTS | 31 |
| 5.7 | Redial last telephone number ATDL..... | 32 |
| 5.8 | Automatic dialing with DTR AT%Dn | 33 |
| 5.9 | Automatic answer ATSO | 34 |
| 5.10 | Incoming Call Bearer +CICB | 34 |
| 5.11 | Single Numbering Scheme +CSNS | 35 |
| 5.12 | Gain control +VGR, +VGT..... | 35 |
| 5.13 | Microphone Mute Control +CMUT | 37 |
| 5.14 | Speaker & Microphone selection +SPEAKER | 38 |
| 5.15 | Echo Cancellation +ECHO..... | 39 |
| 5.16 | SideTone modification +SIDET | 41 |
| 5.17 | Initialize Voice Parameters +VIP..... | 41 |
| 6 | Network service commands | 43 |
| 6.1 | Signal Quality +CSQ..... | 43 |
| 6.2 | Operator selection +COPS | 43 |
| 6.3 | Network registration +CREG | 46 |
| 6.4 | Read operator name +WOPN | 47 |

| | | |
|----------|---|-----------|
| 6.5 | Selection of Preferred PLMN list +CPLS..... | 47 |
| 6.6 | Preferred operator list +CPOL..... | 48 |
| 7 | Security commands | 52 |
| 7.1 | Enter PIN +CPIN..... | 52 |
| 7.2 | Enter PIN2 +CPIN2..... | 54 |
| 7.3 | PIN remaining attempt number +CPINC..... | 55 |
| 7.4 | Facility lock +CLCK..... | 56 |
| 7.5 | Change password +CPWD..... | 57 |
| 8 | Phonebook commands | 59 |
| 8.1 | Select phonebook memory storage +CPBS..... | 59 |
| 8.2 | Read phonebook entries +CPBR..... | 60 |
| 8.3 | Find phonebook entries +CPBF..... | 60 |
| 8.4 | Write phonebook entry +CPBW..... | 61 |
| 8.5 | Phonebook phone search +CPBP..... | 63 |
| 8.6 | Move action in phonebook +CPBN..... | 64 |
| 8.7 | Subscriber number +CNUM..... | 66 |
| 8.8 | Avoid phonebook init +WAIP..... | 66 |
| 8.9 | Delete Calls Phonebook +WDCP..... | 67 |
| 8.10 | Set Voice Mail Number +CSVM..... | 68 |
| 9 | Short Messages commands | 69 |
| 9.1 | Parameters definition | 69 |
| 9.2 | Select message service +CSMS..... | 69 |
| 9.3 | New Message Acknowledgement +CNMA..... | 70 |
| 9.4 | Preferred Message Storage +CPMS..... | 71 |
| 9.5 | Preferred Message Format +CMGF..... | 73 |
| 9.6 | Save Settings +CSAS..... | 74 |
| 9.7 | Restore settings +CRES..... | 74 |
| 9.8 | Show text mode parameters +CSDH..... | 75 |
| 9.9 | New message indication +CNMI..... | 75 |

| | | |
|-----------|--|-----------|
| 9.10 | Read message +CMGR..... | 77 |
| 9.11 | List message +CMGL | 79 |
| 9.12 | Send message +CMGS..... | 80 |
| 9.13 | Write Message to Memory +CMGW..... | 81 |
| 9.14 | Send Message From Storage +CMSS..... | 82 |
| 9.15 | Set Text Mode Parameters +CSMP | 82 |
| 9.16 | Delete message +CMGD | 83 |
| 9.17 | Service center address +CSCA | 85 |
| 9.18 | Select Cell Broadcast Message Types +CSCB..... | 85 |
| 9.19 | Cell Broadcast Message Identifiers +WCBM..... | 86 |
| 9.20 | Message status modification +WMSC..... | 86 |
| 9.21 | Message overwriting +WMGO | 87 |
| 9.22 | Unchange SMS Status +WUSS | 87 |
| 10 | Supplementary Services commands | 89 |
| 10.1 | Call forwarding +CCFC | 89 |
| 10.2 | Call barring +CLCK | 90 |
| 10.3 | Modify SS password +CPWD..... | 91 |
| 10.4 | Call waiting +CCWA..... | 91 |
| 10.5 | Calling line identification restriction +CLIR..... | 93 |
| 10.6 | Calling line identification presentation +CLIP | 93 |
| 10.7 | Connected line identification presentation +COLP | 94 |
| 10.8 | Advice of charge +CAOC | 95 |
| 10.9 | Accumulated call meter +CACM..... | 96 |
| 10.10 | Accumulated call meter maximum +CAMM..... | 97 |
| 10.11 | Price per unit and currency table +CPUC | 98 |
| 10.12 | Call related supplementary services +CHLD..... | 98 |
| 10.13 | List current calls +CLCC | 99 |
| 10.14 | Supplementary service notifications +CSSN | 100 |
| 10.15 | Unstructured supplementary service data +CUSD | 101 |
| 10.16 | Closed user group +CCUG | 102 |

| | | |
|-----------|---|------------|
| 11 | Data commands | 104 |
| 11.1 | Using AT Commands during a data connection..... | 104 |
| 11.2 | Bearer type selection +CBST | 104 |
| 11.3 | Select mode +FCLASS..... | 106 |
| 11.4 | Service reporting control +CR | 106 |
| 11.5 | Cellular result codes +CRC | 107 |
| 11.6 | DTE-DCE local rate reporting +ILRR | 107 |
| 11.7 | Radio link protocol parameters +CRLP..... | 108 |
| 11.8 | Others radio link parameters +DOPT | 109 |
| 11.9 | Select data compression %C..... | 109 |
| 11.10 | V42 bis data compression +DS | 110 |
| 11.11 | V42 bis data compression report +DR | 111 |
| 11.12 | Select data error correcting mode \N..... | 112 |
| | | |
| 12 | Fax commands | 113 |
| 12.1 | Transmit speed +FTM..... | 113 |
| 12.2 | Receive speed +FRM..... | 113 |
| 12.3 | HDLC transmit speed +FTH..... | 114 |
| 12.4 | HDLC receive speed +FRH..... | 114 |
| 12.5 | Stop transmission and wait +FTS | 115 |
| 12.6 | Receive silence +FRS..... | 115 |
| 12.7 | Setting up the PC fax application:..... | 116 |
| | | |
| 13 | Fax class 2 commands..... | 117 |
| 13.1 | Transmit Data +FDT..... | 117 |
| 13.2 | Receive Data +FDR..... | 117 |
| 13.3 | Transmit page punctuation +FET | 117 |
| 13.4 | Page transfer status parameters +FPTS | 118 |
| 13.5 | Terminate Session +FK..... | 118 |
| 13.6 | Page transfer bit order +FBOR..... | 118 |
| 13.7 | Buffer size report +FBUF | 119 |

| | | |
|-----------|--|------------|
| 13.8 | Copy quality checking +FCQ..... | 119 |
| 13.9 | Capability to receive +FCR..... | 120 |
| 13.10 | Current sessions parameters +FDIS | 120 |
| 13.11 | DCE capabilities parameters +FDCC | 122 |
| 13.12 | Local ID string +FLID..... | 122 |
| 13.13 | Page transfer timeout parameter +FPHCTO..... | 123 |
| 13.14 | Fax Class 2 indication messages | 123 |
| 14 | V24-V25 commands | 125 |
| 14.1 | Fixed DTE rate +IPR | 125 |
| 14.2 | DTE-DCE character framing +ICF | 126 |
| 14.3 | DTE-DCE local flow control +IFC | 127 |
| 14.4 | Set DCD signal &C | 128 |
| 14.5 | Set DTR signal &D..... | 128 |
| 14.6 | Set DSR signal &S..... | 128 |
| 14.7 | Back to online mode O..... | 129 |
| 14.8 | Result code suppression Q..... | 129 |
| 14.9 | DCE response format V..... | 129 |
| 14.10 | Default configuration Z..... | 130 |
| 14.11 | Save configuration &W..... | 130 |
| 14.12 | Auto-tests &T..... | 131 |
| 14.13 | Echo E..... | 131 |
| 14.14 | Restore factory settings &F | 131 |
| 14.15 | Display configuration &V | 132 |
| 14.16 | Request identification information I | 132 |
| 14.17 | Data / Commands Multiplexing +WMUX..... | 133 |
| 15 | Specific AT commands | 135 |
| 15.1 | Cell environment description +CCED | 135 |
| 15.2 | Automatic RxLev indication +CCED..... | 136 |
| 15.3 | General Indications +WIND | 136 |
| 15.4 | Analog digital converters measurements +ADC..... | 138 |
| 15.5 | Mobile Equipment event reporting +CMER..... | 139 |

| | | |
|-------|--|-----|
| 15.6 | Read Language Preference +WLPR..... | 140 |
| 15.7 | Write Language Preference +WLPW..... | 140 |
| 15.8 | Read GPIO value +WIOR | 141 |
| 15.9 | Write GPIO value +WIOW..... | 142 |
| 15.10 | Input/Output Management +WIOM..... | 142 |
| 15.11 | Abort command +WAC | 143 |
| 15.12 | Play tone +WTONE..... | 144 |
| 15.13 | Play DTMF tone +WDTMF | 145 |
| 15.14 | Wavecom Downloading +WDWL | 146 |
| 15.15 | Wavecom Voice Rate +WVR..... | 147 |
| 15.16 | Data Rate +WDR | 148 |
| 15.17 | Hardware Version +WHWV | 148 |
| 15.18 | Date of Production +WDOP..... | 149 |
| 15.19 | Wavecom Select Voice Gain +WSVG | 149 |
| 15.20 | Wavecom Status Request +WSTR | 150 |
| 15.21 | Wavecom Scan +WSCAN..... | 151 |
| 15.22 | Wavecom Ring Indicator Mode +WRIM..... | 152 |
| 15.23 | Wavecom 32kHz Power down Mode +W32K..... | 153 |
| 15.24 | Wavecom Change Default Melody +WCDM | 153 |
| 15.25 | Wavecom Software version +WSSW..... | 154 |
| 15.26 | Wavecom Custom Character Set +WCCS..... | 155 |
| 15.27 | Wavecom LoCK +WLCK | 156 |
| 15.28 | CPHS command +CPHS..... | 157 |
| 15.29 | Unsolicited result : Wavecom Voice Mail Indicator +WVMI..... | 158 |
| 15.30 | Wavecom Battery Charge Management +WBCM..... | 159 |
| 15.31 | Features Management +WFM..... | 162 |
| 15.32 | Commercial Features Management +WCFM | 164 |
| 15.33 | Wavecom Customer storage mirror +WMIR | 165 |
| 15.34 | Wavecom Change Default Player +WCDP | 166 |
| 15.35 | Wavecom CPHS Mail Box Number +WMBN | 166 |
| 15.36 | Wavecom Open AT control command +WOPEN | 167 |
| 15.37 | Wavecom Reset +WRST..... | 169 |
| 15.38 | Set Standard Tone +WSST..... | 170 |
| 15.39 | Wavecom Location +WLOC..... | 170 |
| 15.40 | Wavecom Bus Read +WBR | 173 |
| 15.41 | Wavecom Bus Write +WBW..... | 174 |

| | |
|---|------------|
| 15.42 Wavecom Bus Management +WBM | 176 |
| 15.43 Wavecom Hang-up +WATH | 177 |
| 15.44 Write IMEI +WIMEI | 178 |
| | |
| 16 SIM TOOLKIT | 180 |
| 16.1 Overview of SIM Application ToolKit | 180 |
| 16.2 Messages exchanged during a SIM Toolkit operation. | 182 |
| 16.3 SIM TOOLKIT COMMANDS..... | 183 |
| | |
| 17 GPRS commands | 195 |
| 17.1 Define PDP Context +CGDCONT | 195 |
| 17.2 Quality of Service Profile (Requested) +CGQREQ | 198 |
| 17.3 Quality of Service Profile (Minimum acceptable) +CGQMIN | 204 |
| 17.4 GPRS attach or detach +CGATT | 206 |
| 17.5 PDP context activate or deactivate +CGACT | 207 |
| 17.6 Enter data state +CGDATA..... | 209 |
| 17.7 GPRS mobile station class +CGCLASS | 211 |
| 17.8 Select service for MO SMS messages +CGSMS..... | 214 |
| 17.9 GPRS event reporting +CGEREP | 215 |
| 17.10 GPRS network registration status +CGREG | 217 |
| 17.11 Request GPRS IP service 'D' | 218 |
| 17.12 Network requested PDP context activation | 219 |
| 17.13 Automatic response to a network request for PDP context activation +CGAUTO | 220 |
| 17.14 Manual response to a network request for PDP context activation +CGANS | 222 |
| 17.15 Show PDP address +CGPADDR | 224 |
| 17.16 Cellular result codes +CRC | 225 |
| 17.17 Service reporting control +CR | 226 |
| 17.18 Extended error report +CEER..... | 227 |
| 17.19 PDP Counters Infos +CGCOUNTERS | 228 |
| 17.20 GPRS PARAMETERS CUSTO : +WGPRS | 229 |
| 17.21 GPRS-related errors +CME ERROR: <error> | 231 |
| 17.22 Specific GPRS Failure Cause for +CEER | 232 |

| | |
|---|------------|
| 17.23 Full AT commands examples..... | 233 |
| 18 Other AT commands..... | 235 |
| 18.1 V.25 ter recommendation | 235 |
| 18.2 GSM 07.05 recommendation..... | 235 |
| 18.3 GSM 07.07 recommendation..... | 235 |
| 19 Appendices..... | 236 |
| 19.1 ME error result code : +CME ERROR: <error> | 236 |
| 19.2 Message service failure result code: +CMS ERROR : <er> | 238 |
| 19.3 Specific error result codes | 238 |
| 19.4 Failure Cause from GSM 04.08 recommendation (+CEER)..... | 239 |
| 19.5 Specific Failure Cause for +CEER..... | 240 |
| 19.6 GSM 04.11 Annex E-2: Mobile originating SM-transfer..... | 240 |
| 19.7 Unsolicited result codes..... | 242 |
| 19.8 Final result codes | 242 |
| 19.9 Intermediate result codes | 243 |
| 19.10 Parameters storage | 244 |
| 19.11 GSM sequences list..... | 247 |
| 19.12 Operator names..... | 250 |
| 19.13 Data / Commands multiplexing protocol | 258 |
| 20 APPENDIX A (informative) | 261 |
| 20.1 Examples with the PIN required | 261 |
| 20.2 Examples about phonebooks | 263 |
| 20.3 Examples about short messages | 264 |
| 20.4 Examples about Fax class 2 | 265 |

| | | |
|-----------|---|------------|
| 21 | APPENDIX B: Support of SIM ToolKit by The M.E. | 267 |
| 22 | APPENDIX C: Structure of TERMINAL PROFILE..... | 269 |
| 23 | APPENDIX D: Command Type and Next Action Indicator..... | 271 |
| 24 | APPENDIX E: Coding of Alpha fields in the SIM for UCS2 | 272 |
| 25 | APPENDIX F: Specification of Power Down Control via RS232 | 274 |
| 26 | APPENDIX G : Conditions for command execution and dependence to SIM..... | 276 |
| 26.1 | General commands..... | 276 |
| 26.2 | Call Control commands | 276 |
| 26.3 | Network service commands | 277 |
| 26.4 | Security commands..... | 277 |
| 26.5 | Phonebook commands | 277 |
| 26.6 | Short Messages commands | 277 |
| 26.7 | Supplementary Services commands..... | 278 |
| 26.8 | Data commands | 278 |
| 26.9 | Fax commands..... | 278 |
| 26.10 | Class 2 Commands..... | 279 |
| 26.11 | V24-V25 commands..... | 279 |
| 26.12 | Specific AT commands..... | 280 |
| 26.13 | SIM Toolkit commands..... | 280 |

WAVECOM, WISMO are trademarks or registered trademarks of Wavecom S.A.
All other company and/or product names mentioned may be trademarks or
registered trademarks of their respective owners.

1 Introduction

1.1 Scope of this document

This document describes the AT-command based messages exchanged between an application and the WAVECOM products in order to manage GSM related events or services.

1.2 Related documents

This interface specification is based on the following recommendations:

[1] ETSI GSM 07.05: Digital cellular telecommunications system (Phase 2); Use of DTE-DCE interface for Short Message Service (SMS) and Cell Broadcast Service (CBS)

[2] ETSI GSM 07.07: Digital cellular telecommunications system (Phase 2); AT command set for GSM Mobile Equipment (ME)

[3] ITU-T Recommendation V.25 ter: Serial asynchronous automatic dialling and control

[4] ETSI GSM 03.40: Digital cellular telecommunications system (Phase 2); Technical implementation of the Short Message Service (SMS) Point-to-Point (PP)

[5] ETSI GSM 03.38: Digital cellular telecommunications system (Phase 2); Alphabets and language-specific information

[6] ETSI GSM 04.80: Digital cellular telecommunications system (Phase 2); Mobile radio interface layer 3, Supplementary service specification, Formats and coding

1.3 ETSI secretariat

The following addresses may be of use in obtaining the latest GSM recommendations:

Postal address: F-06921 Sophia Antipolis CEDEX – France

Office address: 650 Route des Lucioles – Sophia Antipolis – Valbonne – France

e-mail: secretariat@etsi.fr

Tel: +33 4 92 94 42 00

Fax: +33 4 93 65 47 16

1.4 Definitions

The words, "Mobile Station" (MS) or "Mobile Equipment" (ME) are used for mobile terminals supporting GSM services.

A call from a GSM mobile station to the PSTN is called a "mobile originated call" (MOC) or "outgoing call", and a call from a fixed network to a GSM mobile station is called a "mobile terminated call" (MTC) or "incoming call".

In this document, the word "product" refers to any Wavecom product supporting the AT commands interface.

2 AT commands features

2.1 Wavecom line settings

A serial link handler is set with the following default values (factory settings): autobaud, 8 bits data, 1 stop bit, no parity, RTS/CTS flow control.

Please use the +IPR, +IFC and +ICF commands to change these settings.

2.2 Command line

Commands always start with AT (which means ATtention) and finish with a <CR> character.

2.3 Information responses and result codes

Responses start and end with <CR><LF>, except for the ATV0 DCE response format) and the ATQ1 (result code suppression) commands.

- If command syntax is incorrect, an **ERROR** string is returned.
- If command syntax is correct but with some incorrect parameters, the **+CME ERROR: <Err>** or **+CMS ERROR: <SmsErr>** strings are returned with different error codes.
- If the command line has been performed successfully, an **OK** string is returned.

In some cases, such as "AT+CPIN?" or (unsolicited) incoming events, the product does not return the **OK** string as a response.

In the following examples <CR> and <CR><LF> are intentionally omitted.

3 General behaviors

3.1 SIM Insertion, SIM Removal

SIM card Insertion and Removal procedures are supported. There are software functions relying on positive reading of the hardware SIM detect pin. This pin state (open/closed) is permanently monitored.

When the SIM detect pin indicates that a card is present in the SIM connector, the product tries to set up a logical SIM session. The logical SIM session will be set up or not depending on whether the detected card is a SIM Card or not. The AT+CPIN? command delivers the following responses:

- If the SIM detect pin indicates "absent", the response to AT+CPIN? is "+CME ERROR 10" (SIM not inserted).
- If the SIM detect pin indicates "present", and the inserted Card is a SIM Card, the response to AT+CPIN? is "+CPIN: xxx" depending on SIM PIN state.
- If the SIM detect pin indicates "present", and the inserted Card is not a SIM Card, the response to AT+CPIN? is CME ERROR 10.
- These last two states are not given immediately due to background initialization. Between the hardware SIM detect pin indicating "present" and the previous results the AT+CPIN? sends "+CME ERROR: 515" (Please wait, init in progress).

When the SIM detect pin indicates card absence, and if a SIM Card was previously inserted, an IMSI detach procedure is performed, all user data is removed from the product (Phonebooks, SMS etc.). The product then switches to **emergency mode**.

3.2 Background initialization

After entering the PIN (Personal Identification Number), some SIM user data files are loaded into the product (Phonebooks, SMS status, etc.). Please be aware that it might take some time to read a large phonebook.

The AT+CPIN? command response comes just after the PIN is checked. After this response user data is loaded (in background). This means that some data may not be available just after PIN entry is confirmed by 'OK'. The reading of phonebooks will then be refused by "+CME ERROR: 515" or "+CMS ERROR: 515" meaning, "Please wait, service is not available, init in progress".

This type of answer may be sent by the product at several points:

- when trying to execute another AT command before the previous one is completed (before response),
- when switching from ADN to FDN (or FDN to ADN) and trying to read the relevant phonebook immediately,
- when asking for +CPIN? status immediately after SIM insertion and before the product has determined if the inserted card is a valid SIM Card.

4 General commands

4.1 Manufacturer identification +CGMI

4.1.1 Description :

This command gives the manufacturer identification.

4.1.2 Syntax :

Command syntax : AT+CGMI

| Command | Possible responses |
|---|--|
| AT+CGMI | WAVECOM MODEM OK |
| <i>Note : Get manufacturer identification</i> | <i>Note : Command valid, Wavecom modem</i> |

4.2 Request model identification +CGMM

4.2.1 Description :

This command is used to get the supported frequency bands. With multi-band products the response may be a combination of different bands.

4.2.2 Syntax :

Command syntax : AT+CGMM

| Command | Possible responses |
|------------------------------------|---|
| AT+CGMM | 900P OK |
| <i>Note : Get hardware version</i> | <i>Note : GSM 900 MHz primary band. Other possible answers: "900E" (extended band), "1800" (DCS), "1900" (PCS) or "MULTIBAND"</i> |

4.3 Request revision identification +CGMR

4.3.1 Description :

This command is used to get the revised software version.

4.3.2 Syntax :

Command syntax : AT+CGMR

| Command | Possible responses |
|---|--|
| AT+CGMR <i>Note : Get software version</i> | 310_G250.51 806216 032199 17:04 OK <i>Note : Software release 3.10, revision 51 generated on the 21st of March 1999</i> |

4.4 Product Serial Number +CGSN

4.4.1 Description :

This command allows the user application to get the IMEI (International Mobile Equipment Identity) of the product.

4.4.2 Syntax :

Command syntax : AT+CGSN

| Command | Possible responses |
|---------------------------------------|--|
| AT+CGSN <i>Note : Get the IMEI</i> | 012345678901234 OK <i>Note : IMEI read from EEPROM</i> |
| AT+CGSN <i>Note : Get the IMEI</i> | +CME ERROR: 22 <i>Note : IMEI not found in EEPROM</i> |

4.5 Select TE character set +CSCS

4.5.1 Description :

This command informs the ME which character set is used by the TE. The ME can convert each character of entered or displayed strings. This is used to send, read or write short messages. See also +WPCS for the phonebooks' character sets.

4.5.2 Syntax :

Command syntax : AT+CSCS=<Character Set>

| Command | Possible responses |
|---|---|
| AT+CSCS="GSM" <i>Note : GSM default alphabet</i> | OK <i>Note : Command valid</i> |
| AT+CSCS="PCCP437" <i>Note : PC character set code page 437</i> | OK <i>Note : Command valid</i> |
| AT+CSCS=? <i>Note : Get possible values</i> | +CSCS: ("GSM","PCCP437","CUSTOM","HEX") OK <i>Note : Possible values</i> |

4.5.3 Defined values :

<Character Set>

- "GSM" GSM default alphabet.
- "PCCP437" PC character set code page 437.
- "CUSTOM" User defined character set (cf. +WCCS command).
- "HEX" Hexadecimal mode. No character set used ; the user can read or write hexadecimal values.

4.6 Wavecom Phonebook Character Set +WPCS

4.6.1 Description :

This **specific** command informs the ME which character set is used by the TE for the phonebooks. The ME can convert each character of entered or displayed strings. This is used to read or write phonebook entries. See also +CSCS for the short messages character sets.

4.6.2 Syntax :

Command syntax : AT+WPCS=<Character Set>

| Command | Possible responses |
|---|---|
| AT+WPCS="TRANSPARENT" <i>Note : Transparent mode</i> | OK <i>Note : Command valid</i> |
| AT+WPCS="CUSTOM" <i>Note : Custom character set</i> | OK <i>Note : Command valid</i> |
| AT+WPCS=? <i>Note : Get possible values</i> | +WPCS: ("TRANSPARENT","HEX","CUSTOM") OK <i>Note : Possible values</i> |

4.6.3 Defined values :

<Character Set>

- "TRANSPARENT" Transparent mode. The strings are displayed and entered as they are stored in SIM or in ME.
- "CUSTOM" User defined character set (cf. +WCCS command).
- "HEX" Hexadecimal mode. No character set used ; the user can read or write hexadecimal values.

4.7 Request IMSI +CIMI

4.7.1 Description :

This command is used to read and identify the IMSI (International Mobile Subscriber Identity) of the SIM card. The PIN may need to be entered before reading the IMSI.

4.7.2 Syntax

Command syntax : AT+CIMI

| Command | Possible responses |
|--|--|
| AT+CIMI <i>Note : Read the IMSI</i> | 208200120320598 OK <i>Note : IMSI value (15 digits), starting with MCC (3 digits) / MNC (2 digits, 3 for PCS 1900)</i> |

See appendix 19.12 for MCC / MNC description.

4.8 Card Identification +CCID

4.8.1 Description :

This command orders the product to read the EF-CCID file on the SIM card.

4.8.2 Syntax :

Command syntax : AT+CCID

| Command | Possible responses |
|--|---|
| AT+CCID <i>Note : Get card ID</i> | +CCID: "123456789AB111213141" <i>Note : EF-CCID is present, hexadecimal format</i> |
| AT+CCID? <i>Note : Get current value</i> | + CCID: "123456789AB111213141" <i>Note : Same result as +CCID</i> |
| AT+CCID= ? <i>Note : Get possible value</i> | OK <i>Note : No parameter but this command is valid</i> |

If there is no EF-CCID file present on the SIM, the +CCID answer will not be sent, but the OK message will be returned.

4.9 Capabilities list +GCAP

4.9.1 Description :

This command gets the complete list of capabilities.

4.9.2 Syntax :

Command syntax : AT+GCAP

| Command | Possible responses |
|--|---|
| AT+GCAP <i>Note : Get capabilities list</i> | +GCAP: +CGSM +FCLASS OK <i>Note : Supports GSM and FAX commands</i> |

4.10 Repeat last command A/

4.10.1 Description :

This command repeats the previous command. Only the A/ command itself cannot be repeated.

4.10.2 Syntax :

Command syntax : A/

| Command | Possible responses |
|---|--------------------|
| A/ <i>Note : Repeat last command</i> | |

4.11 Power off +CPOF

4.11.1 Description :

This **specific** command stops the GSM software stack as well as the hardware layer. The AT+CFUN=0 command is equivalent to +CPOF.

4.11.2 Syntax :

Command syntax : AT+CPOF

| Command | Possible responses |
|---|-----------------------------------|
| AT+CPOF <i>Note : Stop GSM stack</i> | OK <i>Note : Command valid</i> |

4.12 Set phone functionality +CFUN

4.12.1 Description :

This command selects the mobile station's level of functionality. When the application wants to stop the product with a power off, or if the application wants to force the product to execute an IMSI DETACH procedure, then it must send:

AT+CFUN=0 (equivalent to AT+CPOF)

This command executes an IMSI DETACH and makes a backup copy of some internal parameters in SIM and in EEPROM. The SIM card cannot then be accessed.

If the mobile equipment is not powered off by the application after this command has been sent, a re-start command (AT+CFUN=1) will have to be issued to restart the whole GSM registration process.

If the mobile equipment is turned off after this command, then a power on will automatically restart the whole GSM process.

The AT+CFUN=1 command restarts the entire GSM stack and GSM functionality: a complete software reset is performed. All parameters are reset to their previous values if AT&W was not used.

If you write entries in the phonebook (+CPBW) and then reset the product directly (AT+CFUN=1, with no previous AT+CFUN=0 command), some entries may not be written (the SIM task does not have enough time to write entries in the SIM card).

In addition, the OK response will be sent at the last baud rate defined by the +IPR command. With the autobauding mode the response can be at a different baud rate, it is therefore preferable to save the defined baud rate with AT&W before directly sending the AT+CFUN=1 command.

4.12.2 Syntax :

Command syntax : AT+CFUN=<functionality level>

| Command | Possible responses |
|---|--|
| AT+CFUN? <i>Note : Ask for current functionality level</i> | +CFUN: 1 OK <i>Note : Full functionality</i> |
| AT+CFUN=0 <i>Note : Set minimum functionality, IMSI detach procedure</i> | OK <i>Note : Command valid</i> |
| AT+CFUN=1 <i>Note : Set the full functionality mode with a complete software reset</i> | OK <i>Note : Command valid</i> |

4.13 Phone activity status +CPAS

4.13.1 Description :

This command returns the activity status of the mobile equipment.

4.13.2 Syntax :

Command syntax : AT+CPAS

| Command | Possible responses |
|--|--------------------|
| AT+CPAS <i>Note : Current activity status</i> | +CPAS: <pas> OK |

4.13.3 Defined values :

<pas>

- 0 ready (allow commands from TA/TE)
- 1 unavailable (does not allow commands)
- 2 unknown
- 3 ringing (ringer is active)
- 4 call in progress
- 5 asleep (low functionality)

4.14 Report Mobile Equipment errors +CMEE

4.14.1 Description :

This command disables or enables the use of the "+CME ERROR : <xxx>" or "+CMS ERROR :<xxx>" result code instead of simply "ERROR". See appendix 19.1 for +CME ERROR result codes description and appendix 0 for +CMS ERROR result codes.

4.14.2 Syntax :

Command syntax : AT+CMEE=<error reporting flag>

| Command | Possible responses |
|--|--------------------|
| AT+CMEE=0 <i>Note : Disable ME error reports, use only « ERROR »</i> | OK |
| AT+CMEE=1 <i>Note : Enable «+CME ERROR: <xxx>» or «+CMS ERROR: <xxx>»</i> | OK |

4.15 Keypad control +CKPD

4.15.1 Description :

This command emulates the ME keypad by sending each keystroke as a character in a <keys> string.

The supported GSM sequences are listed in the appendix.

If emulation fails, a +CME ERROR: <err> is returned.

If emulation succeeds, the result depends on the GSM sequence activated:

<keys>: string of the following characters (0-9,*,#).

Note: In the case where the FDN phonebook is activated, the sequences concerning "call forwarding" are allowed only if the entire sequence is written in the FDN.

4.15.2 Syntax :

Command syntax : AT+CKPD=<keys>

| Command | Possible responses |
|---|--------------------|
| AT+CKPD="*#21#" <i>Note : Check every call forwarding status</i> | +CCFC: 0,7 |
| AT+CKPD="1234" <i>Note : Sequence not allowed</i> | +CME ERROR 3 |

4.16 Clock Management +CCLK

4.16.1 Description :

This command is used to set or get the current date and time of the ME real-time clock.

String format for date/time is: "yy/MM/dd, hh:mm:ss".

Valid years are 98 (for 1998) to 97 (for 2097). The seconds field is not mandatory.

Default date/time is "98/01/01,00:00:00" (January 1st, 1998 / midnight).

4.16.2 Syntax :

Command syntax : AT+CCLK=<date and time string>

| Command | Possible responses |
|--|--|
| AT+CCLK="00/06/09,17:33:00" <i>Note : set date to June 9th, 2000, and time to 5:33pm</i> | OK <i>Note : Date/Time stored</i> |
| AT+CCLK="00/13/13,12:00:00" <i>Note : Incorrect month entered</i> | +CME ERROR 3 |
| AT+CCLK? <i>Note : Get current date and time</i> | +CCLK: "00/06/09,17:34:23" OK <i>Note : current date is June 9th, 2000 current time is 5:34:23 pm</i> |

4.17 Alarm Management +CALA

4.17.1 Description :

This command is used to set alarms date/time in the ME.

String format for alarms : "yy/MM/dd, hh:mm:ss" (see +CCLK).

The maximum number of alarms is 16. Seconds are not taken into account.

4.17.2 Syntax :

Command syntax : AT+CALA=<date and time string> (set alarm)
 AT+CALA="" ,<index> (delete alarm)

| Command | Possible responses |
|---|--|
| AT+CALA="00/06/09,07:30" <i>Note : set an alarm for June 9th, 2000 at 7:30 am</i> | OK <i>Note : Alarm stored</i> |
| AT+CALA="99/03/05,13:00:00" <i>Note : set an alarm for March 5th, 1999 at 1:00 pm</i> | +CME ERROR 3 <i>Note : Invalid alarm (date/time expired)</i> |
| AT+CALA? <i>Note : list all alarms</i> | +CALA: "00/06/08,15:25:00",0 +CALA: "00/06/09,07:30:00",1 +CALA: "00/06/10,23:59:00",2 <i>Note : three alarms are set (index 0, 1, 2)</i> |
| | +CALA: "00/06/08,15:25:00",0 <i>Note : an alarm occurs (index 0)</i> |
| AT+CALA="" ,2 <i>Note : delete alarm index 2</i> | OK <i>Note : Alarm index 2 deleted</i> |
| AT+CALA? <i>Note : list all alarms</i> | +CALA: "00/06/09,07:30:00",1 <i>Note : Only one alarm (index 1)</i> |

4.18 Ring Melody Playback +CRMP

4.18.1 Description

This command allows a melody to be played. All melodies are manufacturer defined.

For incoming voice, data or fax calls, 10 manufacturer-defined melodies can be played back (in a loop).

For an incoming short message, 2 manufacturer-defined sounds can be played back (once). Melody #1: short beep / Melody #2: long beep.

Note:

loop melodies (for voice/data/fax call) must be stopped by a +CRMP command with the <index> field set to 0 (example: +CRMP=0,,0).

When the <volume> parameter is given, this overwrites the <sound level> value of the +CRSL command. If the <volume> parameter is not given, the <sound level> value of +CRSL is used as default value.

4.18.2 Syntax :

Command syntax : AT+CRMP=<call type>[,<volume>,<type>,<index>]

| Command | Possible responses |
|--|--|
| AT+CRMP=0,7,0,2 <i>Note : Play voice call melody index 2 with volume level 7.</i> | OK <i>Note : Melody Playback.</i> |
| AT+CRMP=0,,,0 <i>Note : Stop the melody.</i> | OK <i>Note : The melody is stopped.</i> |
| AT+CRMP=? <i>Note : supported parameters</i> | +CRMP: (0-3),(0-15),0,(0-10) OK |

4.18.3 Defined values :

<call type>

- 0 Incoming voice call
- 1 Incoming data call
- 2 Incoming fax call
- 3 Incoming short message (SMS)

<volume>

- 0 Min volume
- ...
- 6 Default volume
- 15 Max volume

<type>

- 0 Manufacturer Defined (default)

<index>

- 0 Stop Melody Playback
- 1-10 Melody ID for voice/data/fax call type (default : 1)
- 1-2 Melody ID for short message (default : 1)

4.19 Ringer Sound Level +CRSL

4.19.1 Description :

This command is used to set/get the sound level of the ringer on incoming calls. The set command changes the default <volume> value of the +CRMP command.

4.19.2 Syntax :

Command syntax : AT+CRSL=<sound level>

| Command | Possible responses |
|--|---|
| AT+CRSL=0 <i>Note : Set volume to Min.</i> | OK <i>Note : Current ring playing with Min. volume.</i> |
| AT+CRSL=15 <i>Note : Set volume to Max.</i> | OK <i>Note : Current ring playing with Max. volume.</i> |
| AT+CRSL? <i>Note : get current ringer sound level</i> | +CRSL: 15 OK <i>Note : Current level is 15 (max.)</i> |
| AT+CRSL=? <i>Note : supported parameters</i> | +CRSL: (0-15) OK |

4.19.3 Defined values :

<sound level>

- 0 Min volume
- 6 Default volume (default)
- 15 Max volume

5 Call Control commands

5.1 Dial command D

5.1.1 Description :

The ATD command is used to **set a voice, data or fax call**. As per GSM 02.30, the dial command also controls supplementary services.

For a **data or a fax call**, the application sends the following ASCII string to the product (the bearer must be previously selected with the +CBST command):

ATD<nb> where <nb> is the destination phone number.

For a **voice call**, the application sends the following ASCII string to the product: (the bearer may be selected previously, if not a default bearer is used).

ATD<nb>; where <nb> is the destination phone number.

Please note that for an **international number**, the local international prefix does not need to be set (usually 00) but does need to be replaced by the '+' character.

Example: to set up a voice call to Wavecom offices from another country, the AT command is: **"ATD+33146290800;"**

Note that some countries may have specific numbering rules for their GSM handset numbering.

The response to the ATD command is one of the following:

| Verbose code | result | Numeric code (with ATVO set) | Description |
|--------------------|--------|------------------------------|--|
| OK | | 0 | if the call succeeds, for voice call only |
| CONNECT <speed> | | 10,11,12,13,14, 15 | if the call succeeds, for data calls only, <speed> takes the value negotiated by the product. |
| BUSY | | 7 | If the called party is already in communication |
| NO ANSWER | | 8 | If no hang up is detected after a fixed network time-out |
| NO CARRIER | | 3 | Call setup failed or remote user release. Use the AT+CEER command to know the failure cause |

Direct dialling from a phonebook (stored in the SIM card) can be performed with the following command:

ATD> <index>; to call <index> from the selected phonebook (by the +CPBS command)

ATD> "BILL"; to call "BILL" from the selected phonebook

ATD> mem <index> (mem is "SM","LD","MC","ME","RC","MT" or "SN", see +CPBS command) allows direct dialling from a phonebook number. Does not function with "ON" mem.

5.1.2 Syntax :

Command syntax : ATD<nb>[<l>][;]
 ATD>[<mem>]<index>[<l>][;]
 ATD>[<mem>]<name>[<l>][;]

| Command | Possible responses |
|---|---|
| AT+CPBS? <i>Note : Which phonebook is selected ?</i> | +CPBS:"SM",8,10 <i>Note : ADN phonebook is selected, 8 locations are used and 10 locations are available</i> |
| ATD>SM6; <i>Note : Call index 6 from AND phonebook</i> | OK <i>Note : Call succeeds</i> |

When the **FDN phonebook** has been **locked**, only numbers beginning with the digits of FDN phonebook entries can be called.

For example, if "014629" is entered in the FDN phonebook all the phone numbers beginning with these 6 digits can be called.

The **CLIR supplementary service** subscription can be overridden for **this call only**.

"I" means "**invocation**" (restrict CLI presentation).

"i" means "**suppression**" (allow CLI presentation).

Control of CUG **supplementary service** information by "**G**" or "**g**" is allowed for **this call only**. The index and info values set with the +CCUG command are used.

An outgoing call attempt could be refused if the AOC service is active and credit has expired (NO CARRIER).

When trying to set up an outgoing call while there is an active call, the active call is first **put on hold**, then the call set up is carried out.

As per GSM 02.30, **GSM sequences** may be controlled using dial commands. These sequences can contain "*", "#", but ";" is forbidden.

If the sequence is not supported or fails, +CME ERROR: <err> is returned.

In the case where the FDN phonebook is activated, the sequences concerning call forwarding are allowed only if there are written in the FDN.

See paragraph 19.11 to have the list of supported sequences.

| Command | Possible responses |
|---|--|
| ATD*#21# <i>Note : Check any call forwarding status</i> | +CCFC: 0,7 <i>Note : No call forwarding</i> |
| ATD**61*+33146290800**25# <i>Note : Register call forwarding on no reply, with no reply timer fixed at 25 s.</i> | OK <i>Note : done</i> |
| ATD*2# <i>Note : Bad sequence</i> | +CME ERROR 3 |

5.2 Hang-Up command H

5.2.1 Description :

The ATH (or ATH0) command is used by the application to disconnect the remote user. In the case of multiple calls, all calls are released (active, on-hold and waiting calls).

The specific Wavecom ATH1 command has been appended to disconnect the current outgoing call, only in dialing or alerting state (ie. ATH1 can be used only after the ATD command, and before its terminal response (OK, NO CARRIER, ...)). It can be useful in the case of multiple calls.

5.2.2 Syntax :

Command syntax : ATH

| Command | Possible responses |
|---|--|
| ATH <i>Note : Ask for disconnection</i> | OK <i>Note : Every call, if any, are released</i> |
| ATH1 <i>Note : Ask for outgoing call disconnection</i> | OK <i>Note : Outgoing call, if any, is released</i> |

5.3 Answer a call A

5.3.1 Description :

When the product receives a call, it sets the **RingInd** signal and sends the ASCII "RING" or "+CRING: <type>" string to the application (+CRING if the cellular result code +CRC is enabled). Then it waits for the application to accept the call with the ATA command.

5.3.2 Syntax :

Command syntax : ATA

| Command | Possible responses |
|---|---------------------------------------|
| | RING <i>Note : Incoming call</i> |
| ATA <i>Note : Answer to this incoming call</i> | OK <i>Note : Call accepted</i> |
| ATH <i>Note : Disconnect call</i> | OK <i>Note : Call disconnected</i> |

5.4 Remote disconnection

This message is used by the product to inform the application that an active call has been released by the remote user.

The product sends "NO CARRIER" to the application and sets the DCD signal.

In addition, for AOC, the product can release the call if credit has expired (release cause 68 with +CEER command).

5.5 Extended error report +CEER

5.5.1 Description :

This command gives the cause of call release when the last call set up (originating or answering) failed.

5.5.2 Syntax :

Command syntax : AT+CEER

| Command | Possible responses |
|--|---|
| ATD123456789; <i>Note : Outgoing voice call</i> | NO CARRIER <i>Note : Call setup failure</i> |
| AT+CEER <i>Note : Ask for reason of release</i> | +CEER : Error <xxx> OK <i>Note : <xxx>is the cause information element values from GSM recommendation 04.08 or specific Call accepted</i> |

For the cause information element from GSM 04.08 see chapter 18.4 or 18.5. "NO CARRIER" indicates that the AT+CEER information is available for failure diagnosis.

5.6 DTMF signals +VTD, +VTS

5.6.1 +VTD Description :

The product enables the user application to send DTMF tones over the GSM network. This command is used to define tone duration (the default value is 300ms).

To define this duration, the application uses:

AT+VTD=<n> where <n>*100 gives the duration in ms.

If n < 4, tone duration is 300 ms.

5.6.2 +VTD Syntax :

Command syntax : AT+VTD=<n>

| Command | Possible responses |
|--|-----------------------------------|
| AT+VTD=6 <i>Note : To define 600 ms tone duration</i> | OK <i>Note : Command valid</i> |
| AT+VTD=0 <i>Note : To set the default value</i> | OK |

5.6.3 +VTS Description :

The product enables the user application to send DTMF tones over the GSM network. This command enables tones to be transmitted.

To transmit DTMF tones (only when there is an active call), the application uses:

AT+VTS=<Tone> where <Tone> is in {0-9,*,#,A,B,C,D}

5.6.4 +VTS Syntax :

Command syntax : AT+VTS=<Tone>

| Command | Possible responses |
|---|---|
| AT+VTS=A | OK <i>Note : Command valid</i> |
| AT+VTS=11 <i>Note : To set the default value</i> | +CME ERROR: 4 <i>Note : If the <Tone> is wrong</i> |
| AT+VTS=4 | +CME ERROR: 3 <i>Note : If there is no communication</i> |

5.6.5 Informative example :

To send tone sequence 13#, the application sends :

AT+VTS=1;+VTS=3;+VTS=#

OK

5.7 Redial last telephone number ATDL

5.7.1 Description :

This command is used by the application to redial the last number used in the ATD command. The last number dialled is displayed followed by ";" for voice calls only

5.7.2 Syntax :

Command syntax : ATDL

| Command | Possible responses |
|--|--|
| ATDL <i>Note : Redial last number</i> | 0146290800; OK <i>Note : Last call was a voice call. Command valid</i> |

5.8 Automatic dialing with DTR AT%Dn

5.8.1 Description :

This command enables and disables:

- automatic dialling of the phone number stored in the first location of the ADN phonebook,
- automatic sending of the short message (SMS) stored in the first location of the SIM.

The number is dialled when DTR OFF switches ON.

The short message is sent when DTR OFF switches ON.

5.8.2 Syntax :

Command syntax : AT%D<n>[;]

| Command | Possible responses |
|---|---|
| AT%D1; <i>Note : Activates DTR number dialling</i> | OK <i>Note : Command has been executed</i> |
| DTR is OFF DTR switches ON <i>Note : The number in the first location of the ADN is dialled automatically</i> DTR switches OFF <i>Note : The product goes on-hook</i> | |
| AT%D2 <i>Note : Activates DTR short message sending</i> | OK <i>Note : Command has been executed</i> |

5.8.3 Defined values :

<n> (0-2)

to enable or disable automatic message transmission or number dialling. Informs the product that the number is a voice rather than a fax or data number.

AT%D0

Disables automatic DTR number dialling / message transmission.

AT%D1;

Enables automatic DTR dialling if DTR switches from OFF to ON; Dials the phone number in the first location of the ADN phonebook. **Voice call.**

AT%D1

Activates automatic DTR dialling if DTR switches from OFF to ON; Dials the phone number in the first location of the ADN phonebook. **Data or Fax call.**

AT%D2

Activates automatic DTR message transmission if DTR switches from OFF to ON.

5.9 Automatic answer ATSO

5.9.1 Description :

This S0 parameter determines and controls the product automatic answering mode.

5.9.2 Syntax :

Command syntax : ATSO=<value>

| Command | Possible responses |
|--|--|
| ATSO=2 <i>Note : Automatic answer after 2 rings</i> | OK |
| ATSO? <i>Note : Current value</i> | 002 OK <i>Note : always 3 characters padded with zeros</i> |
| ATSO=0 <i>Note : No automatic answer</i> | OK <i>Note : Command valid</i> |

All others S-parameters (S6,S7,S8 ...) are not implemented.

5.10 Incoming Call Bearer +CICB

5.10.1 Description :

This **specific** command is used to set the type of incoming calls when no incoming bearer is given (see +CSNS).

Note:

setting the +CICB command affects the current value of +CSNS.

5.10.2 Syntax :

Command syntax : AT+CICB=<mode>

| Command | Possible responses |
|--|---|
| AT+CICB=1 <i>Note : If no incoming bearer, force a fax call</i> | OK <i>Note : Command accepted</i> |
| AT+CICB=2 <i>Note : If no incoming bearer, force a voice call</i> | OK <i>Note : Command accepted</i> |
| AT+CICB? <i>Note : Interrogate value</i> | +CICB: 2 OK <i>Note : Default incoming bearer: voice call</i> |
| AT+CICB=? <i>Note : Test command</i> | +CICB: (0-2) OK <i>Note : Speech, data or fax default incoming bearer</i> |

5.10.3 Defined values :

<mode>
 0 : Data
 1 : Fax
 2 : Speech

5.11 Single Numbering Scheme +CSNS

5.11.1 Description :

This command selects the bearer to be used when an MT single numbering scheme call is set up (see +CICB).

Note:

setting the +CSNS command affects the current value of +CICB.

5.11.2 Syntax :

Command syntax : AT+CSNS

| Command | Possible responses |
|---|--|
| AT+CSNS=2 <i>Note : force a fax call</i> | OK <i>Note : Command accepted</i> |
| AT+CSNS=0 <i>Note : force a voice call</i> | OK <i>Note : Command accepted</i> |
| AT+CSNS? <i>Note : Interrogate value</i> | +CSNS: 0 OK <i>Note : Default incoming bearer: voice call</i> |
| AT+CSNS=? <i>Note : Test command</i> | +CSNS: (0,2,4) OK <i>Note : Voice, data or fax default incoming bearer</i> |

5.11.3 Defined values :

<mode>
 0 : Voice
 2 : Fax
 4 : Data

5.12 Gain control +VGR, +VGT

5.12.1 Description :

This command is used by the application to tune the receive gain of the speaker and the transmit gain of the microphone. The application sends:

| AT+VGR=<val> | for receive gain | AT+VGT=<val> | for transmit gain | AT+VGT=<val> | for transmit gain |
|----------------|------------------|--------------|-------------------|--------------|-------------------|
| | | Controller 1 | Controller 1 | Controller 2 | Controller 2 |
| 0 to 15 | +6 db | 0 to 31 | +30 db | 0 | +0 db |
| 16 to 31 | +4 db | 32 to 63 | +33 db | 1 | +0,5 db |
| 32 to 47 | +2 db | 64 to 95 | +36 db | 2 | +1 db |
| 48 to 63 | +0 db | 96 to 127 | +39 db | 3 | +1,5 db |
| 64 to 79 | -2 db | 128 to 159 | +42 db | ... | ... |
| 80 to 95 | -4 db | 160 to 191 | +45 db | 19 | +9,5 db |
| 96 to 111 | -6 db | 192 to 223 | +48 db | 20 | +10 db |
| 112 to 127 | -8 db | 224 to 255 | +51 db | 21 (**) | +10.5 db |
| 128 to 143 | -10 db | | | 22 (**) | +11 db |
| 144 to 159 | -12 db | | | 23 (**) | +11.5 db |
| 160 to 175 | -14 db | | | ... | |
| 176 to 191 | -16 db | | | 58 (**) | +29 db |
| 192 to 207 | -18 db | | | 59 (**) | +29.5 db |
| 208 to 223 | -20 db | | | 60 (**) | +30 db |
| 224 to 255 (*) | -22 db | | | 61 | +30,5 db |
| | | | | 62 | +31 db |
| | | | | ... | ... |
| | | | | 101 | +50,5 db |
| | | | | 102 | +51 db |
| | | | | 103 to 127 | reserved |
| | | | | 128 to 242 | reserved |
| | | | | 243 | -6,5 db |
| | | | | 244 | -6 db |
| | | | | 245 | -5,5 db |
| | | | | 246 | -5 db |
| | | | | ... | ... |
| | | | | 255 | -0,5 db |

(*) For Wismo Quik Q22xx : 224 to 239 : -22db / 240 to 255 : -24db

(**) For Wismo Quik Q22xx : 21 to 60 : -+30db

The gain values listed here are relative, for absolute (electrical) values please refer to the specific hardware documentation of the module used in the application.

5.12.2 Syntax :

Command syntax : AT+VGR=<Rgain>
AT+VGT=<Tgain>

| Command | Possible responses |
|--|---|
| AT+VGR=25 | OK <i>Note : Command valid</i> |
| AT+VGT=45 | OK <i>Note : Command valid</i> |
| AT+VGR? <i>Note : Interrogate value</i> | +VGR: 64 OK <i>Note : Default receive gain</i> |
| AT+VGR=? <i>Note : Test command</i> | +VGR : (0-255) OK <i>Note : Possible values</i> |
| AT+VGT? <i>Note : Interrogate value</i> | +VGT: 64 OK <i>Note : Default transmit gain</i> |
| AT+VGT=? <i>Note : Test command</i> | +VGT : (0-255) OK <i>Note : Possible values</i> |

Note : For the AT+VGT ? command with controller 1 set, the value is the lower value of range, where as with controller 2, value correspond to the entered value with AT+VGT=xx.

5.13 Microphone Mute Control +CMUT

5.13.1 Description :

This command is used to mute the microphone input on the product (for the active microphone set with the +SPEAKER command). This command is only allowed during a call.

5.13.2 Syntax :

Command syntax : AT+CMUT=<mode>

| Command | Possible responses |
|---|---|
| AT+CMUT=? <i>Note : Test command</i> | +CMUT : (0,1) OK <i>Note : Enable / disable mute</i> |
| AT+CMUT? <i>Note : Ask for current value</i> | +CMUT : 0 OK <i>Note : Current value is OFF</i> |
| AT+CMUT=1 <i>Note : Mute ON (call active)</i> | OK <i>Note : Command valid</i> |
| AT+CMUT? <i>Note : Ask for current value</i> | +CMUT : 1 OK <i>Note : Mute is active (call active)</i> |
| AT+CMUT=0 <i>Note : Mute OFF (call not active)</i> | +CME ERROR:3 <i>Note : Command not valid</i> |

5.13.3 Defined values :

<mode>

0 : microphone mute off (default value).

1 : microphone mute on.

5.14 Speaker & Microphone selection +SPEAKER

5.14.1 Description

This **specific** command is used to select the speaker and the microphone set.

5.14.2 Syntax :

Command syntax : AT+SPEAKER=<ActiveSpkMic>

| Command | Possible responses |
|---|---|
| AT+SPEAKER=0 <i>Note : Speaker ONE and Micro ONE</i> | OK <i>Note : Command valid</i> |
| AT+SPEAKER? | +SPEAKER: 0 OK <i>Note : Speaker ONE and Micro ONE are active</i> |
| AT+SPEAKER=? | +SPEAKER: (0,1) OK |

5.14.3 Defined values :

<ActiveSpkMic>

0 : SPEAKER ONE, MICRO ONE

1 : SPEAKER TWO, MICRO TWO

5.15 Echo Cancellation +ECHO

5.15.1 Description :

This **specific** command is used to enable, disable or configure the Echo Cancellation functions for voice calls (in rooms, in cars, etc.).

It is necessary to tune the Microphone gain (AT+VGT) and the Speaker gain (AT+VGR) before activating the Echo Cancellation.

5.15.2 Syntax :

Command syntax :

AT+ECHO= <mode> [,<Algold>,
<Param1>,<Param2>,<Param3>,<Param4>,<Param5>,<Param6>]

| Command | Possible responses |
|---|---|
| AT+CMEE=1 <i>Note: Enables the use of result code</i> | OK |
| AT+SPEAKER? | + SPEAKER: 0 OK <i>Note : Speaker ONE and Micro ONE are active</i> |
| AT+SIDET=0 <i>Note: Deactivate the Sidetone</i> | OK |
| AT+SIDET? | +SIDET: 0,0 |
| AT+ECHO? <i>Note : Read current settings</i> | +ECHO: 0,1,0,3,10,7 OK |
| AT+ECHO=1,1,0,3,10,7 <i>Note : Active Echo cancellation 1 for Mic/Spk one.</i> | OK |
| AT+ECHO? <i>Note : Read current settings</i> | +ECHO: 1,1,0,3,10,7 OK |
| AT+ECHO=1,3,30,8000,256 <i>Note : Activate the Echo cancellation 3</i> | +CME ERROR: 519 <i>Note : The new algorithm will be activated after a reset of the product</i> |
| AT+ECHO? <i>Note : Read the Echo cancellation settings</i> | +ECHO: 3,3,30,8000,256 OK |
| AT+CFUN=1 <i>Note: Reset the product</i> | OK |
| AT+ECHO? <i>Note : Read current settings</i> | +ECHO: 1,3,30,8000,256 OK |
| AT+ECHO=0 <i>Note: Deactivate the Echo Cancellation</i> | OK |

5.15.3 Defined values:

<mode>

0 : Deactivate Echo

1 : Activate Echo

When mode = 1 is chosen, **Algold** is mandatory.

<Algold>

- 1 : Echo cancellation 1
- 3 : Echo cancellation 3

To use Echo cancellation 3, the ECHO feature must be activated.

Echo cancellation 1 (4 parameters) :

The parameter **<Volout>** specifies the maximum attenuation of the switch

<Volout>

- 0: 31 db (default)
- 1: 29 db
- 2: 27 db
- 3: 25 db
- ...
- 14: 3 db
- 15: 1 db

The parameter **<Step>** specifies the attenuation step between attenuation and no attenuation.

<Step>

- 0: 1 db
- 1: 2 db
- 2: 3 db
- 3: 4 db (default)

The **<PcmThRel>** parameter specifies the relative threshold between max and min energy information.

The allowed range is [0 ; 31]. (10 by default)

The **<PcmThMax >** parameter specifies threshold of max energy information.

The allowed range is [0 ; 31]. (7 by default)

Echo Cancellation 3 (3 parameters) :

<AlgoParam> high value leads to high echo attenuation but the full-duplex quality will be less efficient.

The allowed range is [0 ; 63]. (30 by default)

<NoiseThres> indicates the noise threshold. Low value leads to high noise attenuation. The threshold 32767 indicates no noise attenuation. The allowed range is [0 ;32767]. (8000 default)

<NmbTaps> indicates the Number of Taps of the Adaptive Filter. The allowed range is [64 ;256]. (256 by default)-64 taps is for short Echo-256 taps is for long Echo.

Read Command: **AT+ECHO?**

This command returns the current settings of the Echo cancellation.

Returns: +ECHO: <Status>, <Algold>, <Param1>, <Param2>, <Param3>, <Param4>, <Param5>, <Param6>

The number of parameters displayed depends on the algorithm used. For Echo cancellation 1, 4 parameters are displayed, 3 parameters are displayed for Echo cancellation 3.

<Status>

- 0 Echo Deactivated.
- 1 Echo Activated for Mic/Spk one.
- 2 Echo Activated for Mic/Spk two.
- 3 Reset the product.

PS: You can activate/deactivate the echo cancellation during a call without resetting the product if the <Algold> parameter is not changed.

5.16 SideTone modification +SIDET

5.16.1 Description :

This **specific** command is used to set the level of audio feedback in the speaker (microphone feedback in the speaker).

5.16.2 Syntax :

Command syntax : AT+SIDET=<val1>,<val2>

| Command | Possible responses |
|--|--|
| AT+SIDET=1,0 | OK <i>Note : Command valid</i> |
| AT+SIDET? <i>Note : Current value</i> | +SIDET: 1,0 OK <i>Note : Command valid</i> |

5.16.3 Defined values :

<val1>

0: SideTone is disabled

1: SideTone is enabled

<val2>

0: 0 db

1: - 6 db

2: - 12 db

3: - 18 db

5.17 Initialize Voice Parameters +VIP

5.17.1 Description :

This command allows factory settings for voice parameters to be restored from EEPROM.

These voice parameters include:

- Gain control (+VGR & +VGT commands),
- Microphone mute control (+CMUT command),
- Speaker & Microphone selection (+SPEAKER command),
- Echo cancellation (+ECHO command),
- Side tone modification (+SIDET command).

5.17.2 Syntax :

Command syntax : AT+VIP=<n>

<n> =1 Restore all voice parameters.

| Command | Possible responses |
|---|---|
| AT+VIP? | +VIP: 1 OK |
| AT+VIP=2 <i>Note : Syntax error</i> | +CME ERROR: 3 |
| AT+VIP=1 <i>Note : Restore the factory settings from EEPROM</i> | OK <i>Note : The command has been executed</i> |
| AT+VIP=1 <i>Note : Restore the factory settings from EEPROM with the current Echo cancellation algo (different of the default algo).</i> | CME ERROR: 519 <i>Note : Reset the product to accept the new algo.</i> |
| AT+VIP=? <i>Note : List of supported <n>s</i> | +VIP: (1) OK |

6 Network service commands

6.1 Signal Quality +CSQ

6.1.1 Description :

This command is used to ascertain the *received signal strength indication* (<rsi>) and the *channel bit error rate* (<ber>) with or without a SIM card inserted.

6.1.2 Syntax :

Command syntax : AT+CSQ

| Command | Possible responses |
|---------|---|
| AT+CSQ | +CSQ: <rsi>,<ber> OK <i>Note : <rsi> and <ber> as defined below</i> |

6.1.3 Defined values :

<rsi> :

0: -113 dBm or less

1: -111 dBm

30: -109 to -53 dBm

31: -51dBm or greater

99: not known or not detectable

<ber> : 0...7: as RXQUAL values in the table GSM 05.08

99: not known or not detectable

6.2 Operator selection +COPS

6.2.1 Description :

There are three possible ways of selecting an operator (PLMN):

- 1) The product is in **manual** mode. It then tries to find the operator specified by the application and if found, tries to register.
- 2) The product is in **automatic** mode. It then tries to find the home operator and if found, tries to register. If not found, the product automatically searches for another network.
- 3) The product enters into **manual/automatic** mode, and then tries to find an operator as specified by the application (as in manual mode). If this attempt fails it enters **automatic** mode. If this is successful, the operator specified by the application is selected. The mobile equipment then enters into **automatic** mode.

Note:

*The read command returns the current mode and the currently selected operator. In manual mode, this PLMN may not be the one set by the application (as it is in the search phase).
These commands are not allowed during one communication.*

6.2.2 Syntax :

To force an attempt to select and register on a network, the application must send the following command:

Command syntax: AT+COPS=<mode>, [<format> [, <oper>]]

Possible responses for AT+COPS=<mode>:

OK (Network is selected with full service)
+CME ERROR: 30 (No network service),
+CME ERROR: 32 (Network not allowed – emergency calls only)
+CME ERROR: 3 (not allowed during one Communication)
+CME ERROR: 4 (Incorrect parameters)
+CME ERROR: 527 (Please wait, and retry your selection later)
+CME ERROR: 528 (Location update failure – emergency calls only)
+CME ERROR: 529 (Selection failure – emergency calls only)

Response syntax for AT+COPS?:

+COPS: <mode> [, <format>, <oper>]

Response syntax for AT+COPS=?:

+COPS: [list of supported (<stat>, long alphanumeric <oper>, short alphanumeric <oper>s, numeric <oper>) s]

If an incoming call occurs during a PLMN list request, the operation is aborted (+CME ERROR: 520) and the unsolicited RING appears

| Command | Possible responses |
|--|---|
| AT+COPS? <i>Note : Ask for current PLMN</i> | +COPS: 0,2,20801 OK <i>Note : Home PLMN is France Telecom Orange</i> |
| AT+COPS=? <i>Note : Ask for PLMN list</i> | +COPS: (2,"F Itin ris", "Itline", "20801"), (3,"F SFR", "SFR", "20810") OK <i>Note : Home PLMN is France Telecom SFR network has been detected</i> |
| AT+COPS=1,2,20810 <i>Note : Ask for registration on SFR network</i> | +CME ERROR: 32 <i>Note : Network not allowed – emergency calls only</i> |
| AT+COPS=1,1,23433 <i>Note : Ask for registration on UK Orange network</i> | +CME ERROR: 529 <i>Note : Selection failed – emergency calls only</i> |
| AT+COPS=0 <i>Note : Ask for registration on home network</i> | OK <i>Note : Succeeded</i> |
| AT+COPS=3,0 <i>Note : Set <format> to long alphanumeric</i> | OK |
| AT+COPS? <i>Note : Ask for current PLMN</i> | +COPS: 0,0,"Orange F" OK <i>Note : Home PLMN is France Telecom Orange</i> |
| AT+COPS=2 <i>Note : Ask for deregistration from network</i> | OK <i>Note : Succeeded</i> |
| AT+COPS? <i>Note : Ask for current PLMN</i> | +COPS: 2 <i>Note : ME is unregistered until <mode>=0 or 1 is selected</i> |

6.2.3 Defined values :

The parameters values are the following ones:

<mode>

0: automatic (**default** value)

1: manual

2: deregistration ; ME will be unregistered until <mode>=0 or 1 is selected.

3: set only <format> (for read command AT+COPS?)

4: manual / automatic (<oper> shall be present), if manual selection fails, automatic mode is entered.

<format>: format of <oper> field

<format>

0: long alphanumeric format <oper>

1: short alphanumeric format <oper>

2: numeric <oper> (**default** value) <stat>: status of <oper>

<stat>

0: unknown

1: available

2: current

3: forbidden

<oper>: operator identifier (MCC/MNC in numeric format only for operator selection)

The long alphanumeric format can be up to 16 characters long (see appendix 19.12 for operator names description, field is "Name")

The short alphanumeric format can be up to 8 characters long.

6.3 Network registration +CREG

6.3.1 Description

This command is used by the application to ascertain the registration status of the product.

6.3.2 Syntax :

Command syntax : AT+CREG= <mode>

Response syntax : +CREG : <mode>, <stat> [,<lac>,<ci>] for AT+CREG? Command only

| Command | Possible responses |
|---|---|
| AT+CREG? | +CREG: <mode>,<stat> OK <i>Note : As defined here-above</i> |
| AT+CREG=0 <i>Note : Disable network registration unsolicited result code</i> | OK <i>Note : Command valid</i> |
| AT+CREG=1 <i>Note : Enable network registration unsolicited result code</i> | OK <i>Note : Command valid</i> |
| AT+CREG=2 <i>Note : Enable network registration and location information unsolicited result code</i> | OK <i>Note : Command valid</i> |
| AT+CREG=? | +CREG: (0-2) <i>Note : 0,1,2 <mode> values are supported</i> |

6.3.3 Defined values :

<mode>

0: Disable network registration unsolicited result code (**default**)

1: Enable network registration code result code +CREG : <stat>

2: Enable network registration and location information unsolicited result code +CREG: <stat>,<lac>,<ci> if there is a change of network cell.

<stat>

0: not registered, ME is not currently searching for a new operator.

1: registered, home network.

2: not registered, ME currently searching for a new operator to register to.

3: registration denied.

4: unknown.

5: registered, roaming.

<lac>: string type; two byte location area code in hexadecimal format (e.g. "00C3" equals 195 in decimal).

<ci>: string type; two byte cell ID in hexadecimal format.

6.4 Read operator name +WOPN

6.4.1 Description :

This **specific** command returns the operator name in alphanumeric format, the numeric format being given.

With E-ONS feature, lac is an optional parameter to read names from OPL/PNN sim files. If it is not entered, name will be given with current lac. Note that in limited service, current lac is set to 0.

6.4.2 Syntax :

Command syntax: AT+WOPN=<format>,<NumOper>[,<lac>]

Response syntax: +WOPN: <format>,<AlphaOper>

| Command | Possible responses |
|---|---|
| AT+WOPN=? <i>Note : Test command</i> | OK |
| AT+WOPN=0,20801 <i>Note : Give an operator in numeric format</i> | +WOPN : 0,"Orange F" OK <i>Note : Alphanumeric answer</i> |
| AT+WOPN=0,99999 <i>Note : Give a wrong operator</i> | +CME ERROR: 22 <i>Note : Not found</i> |
| AT+WOPN=0,20801,36 <i>Note : Give an operator in numeric format for lac 36</i> | +WOPN : 0,"Orange F" OK <i>Note : Alphanumeric answer</i> |

6.4.3 Defined values :

<format> is the required format. Only long (0) and short (1) alphanumeric formats are supported.

<NumOper> is the operator in numeric format.

<AlphaOper> is the operator in long or short alphanumeric format (see appendix 19.12 for operator names description)

<lac> is the two bytes Location Area Code to be used to get the PLMN name. If it is not entered, Current lac will be used (0 if limited service).

6.5 Selection of Preferred PLMN list +CPLS

6.5.1 Description :

This command is used to select one PLMN selector with access technology list in the SIM card that is used by AT+CPOl command.

6.5.2 Syntax :

Command syntax: AT+CPLS= <List>

| Command | Possible responses |
|---|---|
| AT+CPLS? <i>Note : Ask for selection of the SIM file</i> | +CPLS: 1 OK <i>Note : EF_OPLMNwAct is selected</i> |
| AT+CPLS=0 <i>Note : selection of EF PLMNwAct</i> | <i>Note : if EF_PLMNwAct is not present, EF_PLMNsel will be selected</i> |
| AT+CPLS=1 <i>Note : selection of EF OPLMNwAct</i> | +CME ERROR: 3 <i>Note : EF_OPLMNwAct is not present</i> |
| AT+CPLS=? <i>Note : Get possible values</i> | +CPLS: (0,1,2) OK <i>Note : The 3 files with Acces technology are present and can be selected</i> |
| AT+CPLS=? <i>Note : Get possible values</i> | +CPLS: (0) OK <i>Note : Only EF_PLMNwAct or EF_PLMNsel can be selected</i> |

6.5.3 Defined values :

<List>:

0: User controlled PLMN selector with access technology EF_PLMNwAct

Note: if this file is not found EF_PLMNsel will be selected

1: Operator controlled PLMN selector with access technology EF_OPLMNwAct

2: Home PLMN selector with access technology EF_HPLMNwAct

6.6 Preferred operator list +CPOL

6.6.1 Description :

This command is used to edit (or update) the SIM preferred list of networks. This list is read in the SIM file selected by the command AT+CPLS.

6.6.2 Syntax :

Command syntax : AT+CPOL=

[<index>] [,<format>[,<oper>[,<GSM_AcT>,<GSMcomp_Act>,<Utran_Act>]]]

The different possibilities are:

- AT+CPOL = <index> to delete an entry.
- AT+CPOL = , <format> to set the format used by the read command (AT+CPOL?).
- AT+CPOL = , <format>, <oper> to put <oper> in the next free location.
- AT+CPOL = <index> , <format> , <oper> to write <oper> in the <format> at the <index>.
- AT+CPOL = <index>, <format>, <oper>, <GSM_Act>, <GSMcp_Act>, <Utran_Act> to write <oper> in the <format> at the <index> precisising the acces technology (in the case of EF_PLMNwact, EF_HPLMNwact or EF_OPLMNwact is present).

Note: per default if Acces technology parameters are not given, the GSM access technology will be choosen.

The supported format are those of the +COPS command.

The length of this list is limited to 85 entries for *EF_PLMNsel*, and 51 for *EF_PLMNwAct*, *EF_OPLMNwAct*, *EF_HPLMNwAct*.

| Command | Possible responses |
|--|---|
| AT+CPOL? <i>Note : Ask for preferred list of networks With only EF_PLMNsel present</i> | +CPOL:1,2,26201 +CPOL: 6,2,20810 OK <i>Note : Preferred list of networks in numeric format (read in EF_PLMNsel)</i> |
| AT+CPOL? <i>Note : Ask for preferred list of networks With EF_PLMNwAct selected and present</i> | +CPOL:1,2,26201,1,0,0 +CPOL: 6,2,20810,1,0,0 OK <i>Note : Preferred list of networks in numeric format (read in EF_PLMNwAct) GSM acces technology selected GSM compact acces technology not selected Utran acces technology not selected</i> |
| AT+CPOL=,0 <i>Note : Select long alphanumeric format</i> | OK |
| AT+CPOL? <i>Note : Ask for preferred list of networks With only EF_PLMNsel present</i> | +CPOL: 1,0,"D1-TELEKOM" +CPOL: 6,0,"F SFR" OK <i>Note : Preferred list of networks in long alphanumeric format</i> |
| AT+CPOL=7,2,20801 <i>Note : Add a network to the list</i> | OK |
| AT+CPOL? <i>Note : Ask for preferred list of networks With only EF_PLMNsel present</i> | +CPOL: 1,0,"D1-TELEKOM" +CPOL: 6,0,"F SFR" +CPOL: 7,0,"Orange F" OK <i>Note : Preferred list of networks in long alphanumeric format</i> |
| AT+CPOL=7 <i>Note : Delete 7th location</i> | OK |

| | |
|---|--|
| AT+CPOL? <i>Note : Ask for preferred list of networks With only EF_PLMNsel present</i> | +CPOL: 1,0,"D1-TELEKOM" +CPOL: 6,0,"F SFR" OK <i>Note : Preferred list of networks in long alphanumeric format</i> |
| AT+CPOL=8,2,77777 <i>Note : Add a new network to the list With only EF_PLMNsel present</i> | OK |
| AT+CPOL=8,2,77777,0,0,1 <i>Note : Add a new network to the list With EF_PLMNwact present</i> | OK <i>Note: Acces technology UTRAN is selected</i> |
| AT+CPOL=8,2,77777 <i>Note : Add a new network to the list With EF_PLMNwact present</i> | OK <i>Note: Per default Acces technology GSM is selected</i> |
| AT+CPOL? <i>Note : Ask for preferred list of networks With only EF_PLMNsel present</i> | +CPOL: 1,0,"D1-TELEKOM" +CPOL: 6,0,"F SFR" +CPOL: 8,2,77777" OK <i>Note : Preferred list of networks in long alphanumeric format but 8th entry is unknown so the product edits it in the numeric format</i> |
| AT+CPOL=9,0,"Orange F" <i>Note : Add a new network to the list (text format)</i> | |
| AT+CPOL? <i>Note : Ask for preferred list of networks With only EF_PLMNsel present</i> | +CPOL: 1,0,"D1-TELEKOM" +CPOL: 6,0,"F SFR" +CPOL: 8,2,77777" +CPOL: 9,0,"Orange F" OK <i>Note : Preferred list of networks in long alphanumeric format</i> |
| AT+CPOL=? | +CPOL: (1-16),(0-2) OK <i>Note : The EF can accept 16 records, and supported format are 0, 1 or 2.</i> |

6.6.3 Defined values :

<index> : position of the operator record in the sim preferred operator list. Do AT+CPOL=? to get the maximum index of the selected EF.

<format> :

- 0 long alphanumeric format for <oper>
- 1 short alphanumeric format for <oper>
- 2 numeric format for <oper>

<oper> : characterstring or integer (see <format>) indicating operator identifier.

<GSM_Act> : GSM access technology

<GSMcomp_Act> : GSM compact access technology

<Utran_Act> : UTRA access technology

0 access technology not selected

1 access technology selected

7 Security commands

7.1 Enter PIN +CPIN

7.1.1 Description :

This command is used to enter the ME passwords (CHV1 / CHV2 / PUK1 / PUK2, etc.), that are required before any ME functionality can be used.

CHV1/CHV2 is between **4** and **8** digits long, **PUK1/PUK2** is **only 8 digits** long.

If the user application tries to make an outgoing call before the SIM PIN code (CHV1) has been confirmed, then the product will refuse the "ATD" command with a "+CME ERROR: 11" (SIM PIN required).

The application is responsible for checking the PIN after each reset or power on - if the PIN was enabled.

7.1.2 Syntax :

Command syntax: AT+CPIN=<pin>

| Command | Possible responses |
|---|---|
| AT+CPIN=1234 <i>Note : Enter PIN</i> | OK <i>Note : PIN code is correct</i> |
| AT+CPIN=5678 <i>Note : Enter PIN</i> | +CME ERROR : 3 <i>Note : Operation not allowed, PIN previously entered</i> |

After 3 unsuccessful attempts to enter the PIN (Personal Identification Number), the PUK (Personal Unblocking Key) will be required. PUK validation forces the user to enter a new PIN code as a second parameter and this will be the new PIN code if PUK validation succeeds. CHV1 is then **enabled** if PUK1 is correct. The application therefore uses this command:

AT+CPIN=<Puk>,<NewPin>

| Command | Possible responses |
|--|---|
| AT+CPIN=00000000,1234 <i>Note : Enter PUK and new PIN</i> | +CME ERROR: 16 <i>Note : Incorrect PUK</i> |
| AT+CPIN=12345678,1234 <i>Note : Enter PUK and new PIN, 2nd attempt</i> | OK <i>Note : PUK correct, new PIN stored</i> |

To ascertain which code must be entered (or not), the following query command can be used:

AT+CPIN?

The possible responses are :

| | |
|-------------------|--|
| +CPIN: READY | <i>ME is not pending for any password</i> |
| +CPIN: SIM PIN | <i>CHV1 is required</i> |
| +CPIN: SIM PUK | <i>PUK1 is required</i> |
| +CPIN: SIM PIN2 | <i>CHV2 is required</i> |
| +CPIN: SIM PUK2 | <i>PUK2 is required</i> |
| +CPIN: PH-SIM PIN | <i>SIM lock (phone-to-SIM) is required</i> |
| +CPIN: PH-NET PIN | <i>Network personalisation is required</i> |
| +CME ERROR: <err> | <i>SIM failure (13) absent (10) etc...</i> |

Please note that in this case the mobile equipment does not end its response with the OK string.

The response +CME ERROR : 13 (SIM failure) is returned after 10 unsuccessful PUK attempts. The SIM card is then out of order and must be replaced by a new one.

Example: 3 failed PIN validations + 1 successful PUK validation

| | |
|--------------------------------|--|
| AT+CPIN? +CPIN: SIM PIN | <i>Read the PIN status The product requires SIM PIN</i> |
| AT+CPIN=1235 +CME ERROR: 16 | <i>First attempt to enter a SIM PIN Wrong PIN</i> |
| AT+CPIN=1236 +CME ERROR: 16 | <i>Second attempt Wrong PIN</i> |
| AT+CPIN=1237 +CME ERROR: 16 | <i>Third attempt Wrong PIN</i> |
| AT+CPIN? +CPIN: SIM PUK | <i>Read PIN state The product requires PUK</i> |
| AT+CPIN=99999999,5678 OK | <i>The PUK is entered, the new PIN shall be 5678 PUK validation is OK. New Pin is 5678</i> |
| AT+CPIN? +CPIN: READY | <i>Read PIN state The product is ready</i> |

If the user tries to do something which requires PIN2 (CHV2), the product will refuse the action with a "+CME ERROR: 17" (SIM PIN2 required). The product then waits for SIM PIN2 to be given.

Of course, if SIM PIN2 is blocked, SIM PUK2 is required instead of SIM PIN2. For example, the product needs PIN2 to write in the fixed dialling phonebook (FDN) , so if SIM PIN2 authentication has not been performed during the current session, SIM PIN2 is required

| Command | Possible responses |
|--|--|
| AT+CPBS="FD" <i>Note : Choose FDN</i> | OK |
| AT+CPBW=5,"01290917",129,"Jacky" <i>Note : Write in FDN at location 5</i> | +CME ERROR: 17 <i>Note : SIM PIN2 is required</i> |
| AT+CPIN? | SIM PIN2 <i>Note : SIM PIN2 is required</i> |
| AT+CPIN=5678 <i>Note : Enter SIM PIN2</i> | OK |
| AT+CPBW=2,"01290917",129,"Jacky" <i>Note : Write in FDN at location 5</i> | OK <i>Note : Now writing in FDN is allowed</i> |

Please note that the product only requests PIN2 or PUK2 once. Therefore, if they are not entered properly, the next +CPIN? command will return "+CPIN: READY".

7.2 Enter PIN2 +CPIN2

7.2.1 Description :

This **specific** command is used to validate the PIN2 code (CHV2), or to validate the PUK2 code (UNBLOCK CHV2) and to define a new PIN2 code.

Of course, the +CPIN command allows PIN2 or PUK2 codes to be validated, but **only** when the **last command executed resulted in PIN2 authentication failure**.

PIN2 length is between 4 and 8 digits, PUK2 length is 8 digits only.

7.2.2 Syntax :

Command syntax : AT+CPIN2=<pin2>

| Command | Possible responses |
|---|---|
| AT+CPIN2=1234 <i>Note : Enter PIN2</i> | OK <i>Note : PIN2 code is correct</i> |
| AT+CPIN2=5678 <i>Note : Enter PIN2</i> | +CME ERROR: 3 <i>Note : Operation not allowed, PIN2 previously entered</i> |

After 3 unsuccessful attempts, PUK2 will then be required. PUK2 validation forces the user to enter a new PIN2 code as a second parameter and this will be the new PIN2 code if PUK1 validation succeeds. The application therefore uses this command:

AT+CPIN2=<puk2>,<NewPin2>

| Command | Possible responses |
|---|---|
| AT+CPIN2=00000000,1234 <i>Note : Enter PUK2 and new PIN2</i> | +CME ERROR: 16 <i>Note : Incorrect Password (PUK2)</i> |
| AT+CPIN2=12345678,1234 <i>Note : Enter PUK2 and new PIN2, 2nd attempt</i> | OK <i>Note : PUK2 correct, new PIN2 stored</i> |

To ascertain which code must be entered (or not), the following query command can be used:

AT+CPIN2?

The possible responses are

| | |
|-------------------|---------------------------|
| +CPIN2: READY | <i>No PIN2 is needed</i> |
| +CPIN2: SIM PIN2 | <i>PIN2 is required</i> |
| +CPIN2: SIM PUK2 | <i>PUK2 is required</i> |
| +CME ERROR: <err> | <i>Absent (10) etc...</i> |

7.3 PIN remaining attempt number +CPINC

7.3.1 Description :

This **specific** command is used to get the number of valid attempts for PIN1 (CHV1), PIN2 (CHV2), PUK1 (UNBLOCK CHV1) and PUK2 (UNBLOCK CHV2) identifiers.

7.3.2 Syntax :

Command syntax : AT+CPINC

Response syntax : +CPINC : <n1>,<n2>,<k1>,<k2>

| Command | Possible responses |
|---|--|
| AT+CPINC <i>Note : Get the number of attempts left</i> | +CPINC : 2,3,10,10 OK <i>Note : First CHV1 attempt was a failure</i> |
| AT+CPINC? <i>Note : Get current values</i> | +CPINC : 2,3,10,10 OK <i>Note : First attempt was a failure</i> |
| AT+CPINC=? <i>Note : Get possible values</i> | OK |

7.3.3 Defined values

<n1>, <n2> are the attempts left for PIN1, PIN2 (0 = blocked, 3 max)
<k1>, <k2> are the attempts left for PUK1, PUK2 (0 = blocked, 10 max)
For this to work, the card should be present at the time of initialization, otherwise an error will be sent (+CME ERROR : 10).

7.4 Facility lock +CLCK

7.4.1 Description :

This command is used by the application to lock, unlock or interrogate an ME or network facility <fac>.

Nota: Test SIM cards (with MCC=001 & MNC=01) doesn't check "PS", "PN", "PU", "PP" and "PC" locks.

7.4.2 Syntax :

Command syntax: AT+CLCK= <fac>,<mode>[,<passwd>[,<class>]]

Response syntax: +CLCK: <status> [,<class1>]<CR><LF>+CLCK: <status>,<class2> [...]]

| Command | Possible responses |
|---|---|
| AT+CLCK="SC",1,1234 <i>Note : Enable PIN</i> | OK <i>Note : PIN was correct</i> |
| AT+CLCK? <i>Note : Read PIN status</i> | +CLCK:("PS",0),("SC",0),("FD",0),("PN",0),("PU",0),("PP",0),("PC",0) OK <i>Note : PIN is enabled, no SIM lock, no network lock, no information on Call barring (no longer supported in GSM 07.07)</i> |
| AT+CLCK="SC",0,5555 <i>Note : Disable PIN</i> | +CME ERROR: 16 <i>Note: PIN was wrong</i> |
| AT+CPIN=1234 <i>Note : Enter PIN</i> | OK <i>Note : PIN was good</i> |
| AT+CLCK=? <i>Note : Request supported facilities</i> | +CLCK: ("PS","SC","AO","OI","OX","AI","IR","AB","AC","FD","PN","PU","PP","PN") OK <i>Note : Supported facilities</i> |
| AT+CLCK="PN",1,12345678 <i>Note : Activate network lock</i> | OK <i>Network lock activated</i> |
| AR+CLCK="AO",1,1234,2 <i>Note : Activate all outgoing calls barring for data calls</i> | OK <i>Note : Call barring is activate</i> |
| AT+CLCK="AO",2 <i>Note : Query BAOC status</i> | +CLCK : 1,2 OK <i>Note : BAOC activate for data calls only</i> |
| AT+CLCK="SC",0,0000 <i>Note : Disable PIN</i> | +CME ERROR: 521 <i>Note : PIN deactivation is forbidden with this SIM card</i> |

7.4.3 Defined values :

The following <fac> values are supported:

- "PS" : SIM lock facility with a 8 digits password.
- "SC" : PIN enabled (<mode> = 1) / disabled (<mode> = 0)
- "AO" : BAOC (Barr All Outgoing Calls)
- "OI" : BOIC (Barr Outgoing International Calls)
- "OX" : BOIC-exHC (Barr Outgoing. International Calls except to Home Country)
- "AI" : BAIC (Barr All Incoming Calls)
- "IR" : BIC-Roam (Barr Inc. When Roaming outside Home Country)
- "AB" : All Barring services
- "AG" : All outGoing barring services
- "AC" : All inComing barring services
- "PN" : Network lock with a 8 digits password (NCK).
- "PU" : Network Subset lock with a 8 digits password (NSCK).
- "PP" : Service Provider lock with a 8 digits password (SPCK).
- "PC" : Corporate lock with a 8 digits password (CCK).
- "FD" : SIM Fixed Dialing Numbers (FDN) memory feature (PIN2 is required as <password>)

<mode>

- 0 : unlock the facility
- 1 : lock the facility
- 2 : query status

<class> : A facility status can be changed for only one class, or for all classes (7 or omitted).

<class>

- 1 : Voice (telephony)
- 2 : Data (apply to all bearer services)
- 4 : Fax (facsimile services)
- 8 : Short Message service
- 7 : Equal to all classes (Default value)

Any attempt to combine different classes will result in activation / deactivation / interrogation of all classes.

Password maximum length is given with the AT+CPWD=? Command.

Note: It will not possible to lock the FDN phonebook if this one is not loaded.

7.5 Change password +CPWD

7.5.1 Description :

This command is used by the application to change a password (PIN, call barring, NCK, etc.). The facility values (<fac>) are the same as for the +CLCK command with a "P2" facility to manage SIM PIN2.

For the network lock ("PN"), unlocking is forbidden after 10 failed attempts to disable (unlock) the network lock with an incorrect password.

7.5.2 Syntax :

Command syntax : AT+CPWD= <fac>, <oldpwd>, <newpwd>

| Command | Possible responses |
|--|---|
| AT+CPWD=? <i>Note : Possible values</i> | +CPWD: ("PS",8),("SC",8),("AO",4),("OI",4),("OX",4), (), ("AI",4),("IR",4),("AB",4),("AG",4),("AC",4), ("P2",8),("FD",8),("PN",8),("PU",8),("PP",8), ("PC",8) OK <i>Note : CHV1/CHV2 must be on 8 digits maximum (4mn)</i> <i>For call barring, on 4 digits maximum</i> |
| AT+CPWD="SC",1234,5555 <i>Note : Change PIN</i> | OK <i>Note : PIN was correct</i> |
| AT+CPWD="SC",1234,5555 <i>Note : Change PIN</i> | +CME ERROR: 16 <i>Note: PIN was wrong</i> |
| AT+CPIN=5555 <i>Note : Enter PIN</i> | OK <i>Note : PIN was correct</i> |
| AT+CPWD="PN",12345678,00000000 <i>Note : Change NCK</i> | OK <i>Note : NCK changed for net lock</i> |

8 Phonebook commands

8.1 Select phonebook memory storage +CPBS

8.1.1 Description :

This command selects phonebook memory storage. The available phonebooks are:

- "SM" : ADN (SIM phonebook)
- "FD" : FDN (SIM Fix Dialling, restricted phonebook)
- "ON" : MSISDN (SIM own numbers)
- "EN" : EN (SIM emergency number)
- "LD" : LND (combined ME and SIM last dialing phonebook)
- "MC" : MSD (ME missed calls list)
- "ME" : ME (ME phonebook)
- "MT" : MT (combined ME and SIM phonebook)
- "RC" : LIC (ME received calls list)
- "SN" : SDN (Services dialing phonebook)

8.1.2 Syntax :

Command syntax : AT+CPBS

| Command | Possible responses |
|--|---|
| AT+CPBS="SM" <i>Note : Select ADN phonebook</i> | OK <i>Note : ADN phonebook is selected</i> |
| AT+CPBS=? <i>Note : Possible values</i> | +CPBS: ("SM","LD","MC","ON","ME","RC","MT","SN") OK <i>Note : only "EN" phonebook is not supported with this SIM card.</i> |
| AT+CPBS? <i>Note : Status</i> | +CPBS : "SM",10,20 OK <i>Note: ADN phonebook selected, 10 locations used, 20 locations available</i> |

The ADN phonebook could not be selected as FDN is active.

8.2 Read phonebook entries +CPBR

8.2.1 Description :

This command returns phonebook entries for a range of locations from the current phonebook memory storage selected with +CPBS.

Note :

for all phonebook read commands (+CPBR, +CPBF, +CPBN, +CPBP, +CNUM), the TON/NPI MSB of each number is set to 1 (ex : a TON/NPI stored as 17 is displayed as 145).

8.2.2 Syntax :

Command syntax : AT+CPBR

| Command | Possible responses |
|---|--|
| AT+CPBR=? <i>Note : Test command</i> | +CPBR: (1-50),20,10 OK <i>Note : 50 locations (from 1 to 50), max length for phone number is 20 digits, 10 characters max for the text</i> |
| AT+CPBR=12,14 <i>Note : Read entries from 12 to 14</i> | +CPBR : 12,"112",129,"Emergency" +CPBR : 13,"+331290909",145,"Fred" +CPBR : 14,"0146290808",129,"Zazi" OK <i>Note : Display locations 12,13,14 with location, number, type (TON/NPI), Text</i> |
| AT+CPBR=10 <i>Note : Read entry 10</i> | +CPBR :10,"0146290921",129,"Rob" OK <i>Note: Display location 10</i> |
| AT+CPBR=11 <i>Note : Read entry 11 (UCS2 format)</i> | +CPBR :11,"0146290921",129,"8000010002FFF F" OK <i>Note: Display location 11</i> |
| AT+CPBR=52 <i>Note : Read entry 52 (wrong)</i> | +CME ERROR: 21 <i>Note : Invalid index</i> |

8.3 Find phonebook entries +CPBF

8.3.1 Description :

This command returns phonebook entries with alphanumeric fields starting with a given string. The AT+CPBF= "" command can be used to display all phonebook entries sorted in alphabetical order.

This command is not allowed for "LD", "RC", "MC", "SN" phonebooks and for the "EN" phonebook, which does not contain alphanumeric fields.

It is possible to use this command with UCS2 strings. If a wrong UCS2 format is entered, the string is considered as an ASCII string.

8.3.2 Syntax :

Command syntax : AT+CPBF

| Command | Possible responses |
|--|---|
| AT+CPBF=? <i>Note : Test command</i> | +CPBF: 20,10 OK <i>Note : Max length for phone number is 20 digits, 10 characters for the text</i> |
| AT+CPBF="E" <i>Note : Read entries with "E"</i> | +CPBF : 12,"112",129,"Emergency" +CPBF : 15,"+331290101",145,"Eric" OK <i>Note : Display locations with text field starting with "E"</i> |
| AT+CPBF="H" <i>Note : Read entries with "H"</i> | +CME ERROR: 22 <i>Note: Entry not found</i> |
| AT+CPBF="800001FFFF" <i>Note : Read entries starting with 0001 UCS2 character</i> | +CPBF : 11, "0146290921",129,"8000010002FFFF" OK <i>Note : Display locations with text field starting with 0001 UCS2 character</i> |
| AT+CPBF="8045C" <i>Note : Read entries with "8045C" (ASCII format)</i> | +CME ERROR: 22 <i>Note: Entry not found. The string has a wrong UCS2 format, it is therefore considered as an ASCII string</i> |

8.4 Write phonebook entry +CPBW

8.4.1 Description :

This command writes a phonebook entry in location number *<index>* in the current phonebook memory storage.

"RC" and "MC" phonebooks could be only erased by +CPBW. Adding field and/or modifying field is not allowed for these phonebooks.

This command is not allowed for "EN", "LD", "MC", "RC", "MT", "SN" phonebooks, which can not be written.

8.4.2 Syntax :

Command syntax : AT+CPBW=<index>[,<number>[,<type>[,<text>]]]

| Command | Possible responses |
|---|--|
| AT+CPBW=? <i>Note : Test command</i> | +CPBW: (1-50),20,(129,145),10 OK <i>Note : 50 locations, phone number = 20 digits max, TON/NPI of 129 or 145, text length = 10</i> |

| | |
|--|--|
| AT+CPBW= 3 <i>Note : Erase location 3</i> | OK <i>Note: Location 3 erased</i> |
| AT+CPBW=5,"112",129,"SOS" <i>Note : Write at location 5</i> | OK <i>Note: Location 5 written</i> |
| AT+CPBW=5,"01290917",129,"Jacky" <i>Note : Overwrite location 5</i> | OK <i>Note : Location 5 overwritten</i> |
| AT+CPBW=6,"01292349",129,"8000410042" <i>Note : write location 6 (UCS2 format for the <text> field)</i> | OK <i>Note : Location 6 is written</i> |
| AT+CPBW=,"+33145221100",145,"SOS" <i>Note : Write at the first location available</i> | OK <i>Note : First location available is written</i> |
| AT+CPBW=,"0345221100",129,"SOS" <i>Note : Write at the first location available</i> | +CME ERROR: 20 <i>Note : Phonebook full</i> |
| AT+CPBW=57,"112",129,"WM" <i>Note : Write at location 57 (wrong)</i> | +CME ERROR: 21 <i>Note : Invalid index</i> |
| AT+CPBW=7,"012345678901234567890",129,"WAVE" <i>Note : Write at location 7 a phone number exceeding the limit (21 digits)</i> | +CME ERROR: 26 <i>Note : Phone number too long</i> |
| AT+CPBW=7,"0122334455",129,"WAVECOM TEL" <i>Note : Write at location 7 along text (11 characters)</i> | +CME ERROR: 24 <i>Note : Text too long</i> |
| AT+CPBW=8,"01292349",129,"80xyz" <i>Note : write location</i> | OK <i>Note : Location 8 is written. The string has a wrong UCS2 format, it is therefore considered as an ASCII string</i> |

When the fixed dialling phonebook (FDN) is locked, this command is not allowed. Moreover, **when the FDN is unlocked, PIN2 is required to write** in the FDN phonebook.

But if PIN2 authentication has been performed during the current session, the +CPBW command with FDN is allowed.

| Command | Possible responses |
|--|--|
| AT+CPBS="FD" <i>Note : Choose FDN</i> | OK |
| AT+CPBW=5,"01290917",129,"Jacky" <i>Note : Write in FDN at location 5</i> | +CME ERROR: 17 <i>Note : SIM PIN2 is required</i> |
| AT+CPIN? | SIM PIN2 <i>Note: SIM PIN2 is required</i> |
| AT+CPIN=5678 <i>Note : Enter SIM PIN2</i> | OK |
| AT+CPBW=5,"01290917",129,"Jacky" <i>Note : Write in FDN at location 5</i> | OK <i>Note : Writing in FDN is now allowed</i> |

8.4.3 Defines values :

<index> integer type value depending on the capacity of the phonebook memory.

<number> phone number in ASCII format.

<type> TON/NPI (Type of address octet in integer format).

Note:

for the <type> parameter, all values are allowed from 0 to 255, but the MSB will be set to 1 in all cases (ex : a <type> value of 17 will be written as 145).

<text> string type.

Note 1:

For the <text> parameter all strings starting with "80", "81" or "81" are considered in UCS2 format. See the APPENDIX E (Coding of Alpha fields in the SIM for UCS2).

Note 2:

The +CSCS (Select Character set) command does not affect the format for phonebook entries.

8.5 Phonebook phone search +CPBP

8.5.1 Description :

This **specific** command orders the product to search the phonebook for an item with the same phone number as that defined in the parameter.

8.5.2 Syntax :

Command syntax : AT+CPBP=<PhoneNumber>

<PhoneNumber> is coded like any GSM 07.07 or GSM 07.05 phone number.

| Command | Possible responses |
|---|---|
| AT+CPBP="+331290101" <i>Note : Search entries corresponding to this phone number</i> | +CPBP : 15,"+331290101",145,"Eric" OK <i>Note : Display the entry corresponding to the specified phone number</i> |
| AT+CPBP="+331290101" <i>Note : Search entries corresponding to this phone number</i> | +CPBP : 15,"01290101",129,"Eric" OK <i>Note : Display the entry corresponding to the specified phone number</i> |
| AT+CPBP="01290202" <i>Note : Search entries corresponding to this phone number</i> | +CPBP : 15,"+331290202",145,"David" OK <i>Note : Display the entry corresponding to the specified phone number</i> |
| AT+CPBP="+331288575" <i>Note : Search entries corresponding to this phone number</i> | +CPBP : 15,"+331290101",145,"8045682344FFFF" (UCS2 format) OK <i>Note : Display the entry corresponding to the specified phone number</i> |
| AT+CPBP="0129" <i>Note : Search entries corresponding to this phone number</i> | +CME ERROR: 22 <i>Note : Entry not found</i> |

8.6 Move action in phonebook +CPBN

8.6.1 Description

This specific command instructs the product to make a forward or backward move in the phonebook (in alphabetical order).

This command is not allowed for the "EN" phonebook - which does not contain alphanumeric fields.

8.6.2 Syntax :

Command syntax : AT+CPBN=<mode>

| Command | Possible responses |
|---|---|
| AT+CPBN=? <i>Note : Test command</i> | +CPBN: (0-5) OK <i>Note : Possible modes</i> |
| AT+CPBN=0 <i>Note : Read the first location</i> | +CPBN : 15,"+331290101",145,"Eric" OK <i>Note : Display the first location</i> |
| AT+CPBN=2 <i>Note : Read the next location</i> | +CPBN : 5,"+33147658987",145,"Frank" OK <i>Note : Display the second location</i> |
| AT+CPBN=2 <i>Note : Read the next location</i> | +CPBN : 6,"+331290302",145,"Marc" OK <i>Note : Display the third location</i> |
| AT+CPBN=3 <i>Note : Read the previous location</i> | +CPBN : 5,"+33147658987",145,"Frank" OK <i>Note : Display the second location</i> |
| AT+CPBN=1 <i>Note : Read the last location</i> | +CPBN : 6,"+331290302",145,"Marc" OK <i>Note : Display the last location</i> |
| AT+CPBN=2 <i>Note : Read the next location</i> | +CPBP : 15,"+331290101",145,"Eric" OK <i>Note : Display the first location</i> |

Using mode 4 and 5 with +CPBF command and CPBW :

| Command | Possible responses |
|---|--|
| AT+CPBF="Er" <i>Note : Find "Er" in phonebook</i> | +CPBF : 15,"+331290101",145,"Eric" OK <i>Note : Display the location</i> |
| AT+CPBN=2 <i>Note : Read the next location</i> | +CPBN : 5,"+33147658987",145,"Frank" OK <i>Note : Display the following location</i> |
| AT+CPBF="Er" <i>Note : Find "Er" in phonebook</i> | +CPBF : 15,"+331290101",145,"Eric" OK <i>Note : Display the location</i> |
| AT+CPBN=4 <i>Note : Get the last location read</i> | +CPBF : 15,"+331290101",145,"Eric" OK <i>Note : Display the last location read</i> |
| AT+CPBW=,"0146290800",129,"WM" <i>Note : Write an item at the first location available</i> | OK <i>Note : No information about this location</i> |
| AT+CPBN=4 <i>Note : Get the last location read</i> | +CPBF : 15,"+331290101",145,"Eric" OK <i>Note : Display the last location read</i> |
| | AT+CPBN=38,"0146290800,129,"WM" <i>Note : Display the last item written with its location</i> |
| AT+CPBN=4 <i>Note : Get the last item read</i> | AT+CPBN=38,"0146290800,129,"WM" <i>Note : Now the last item read is the last written item too</i> |
| AT+CPBF="800041FFFF" <i>Note : Find "800041" in phonebook</i> | +CPBF : 15,"+3312345",145,"8000414339FFFF" OK <i>Note : Display this location</i> |
| AT+CPBN=4 <i>Note : Get the last location read</i> | +CPBF : 15,"+3312345",145,"8000414339FFFF" OK <i>Note : Display the last location read</i> |

Please note that the AT+CPBN=5 command is useful after an AT+CPBW command used without a location.

8.6.3 Defined values :

<mode>

- 0: First item
- 1: Last item
- 2: Next valid item in alphabetical order
- 3: Previous valid item in alphabetical order
- 4: Last item read (usable only if a read operation has been performed on the current phonebook since the end of initialization (+WIND: 4))
- 5: Last item written (usable only if a write operation has been performed on the current phonebook since the end of initialization (+WIND: 4))

8.7 Subscriber number +CNUM

8.7.1 Description :

This command returns the subscriber MSISDN(s).
If the subscriber has different MSISDNs for different services, each MSISDN is returned in a separate line.

8.7.2 Syntax :

Command syntax: AT+CNUM

Response syntax: +CNUM : <alpha1>, <number1>, <type1>
<CR><LF> +CNUM : <alpha2>, <number2>, <type2>

| Command | Possible responses |
|--|---|
| AT+CNUM <i>Note : Get MSISDN(s)</i> | +CNUM : "Phone", "0612345678",129 +CNUM : "Fax", "0687654321",129 +CNUM : "80001002FFFF", "+0183773", 145 (UCS2 format) OK <i>Note : MSISDNs</i> |
| AT+CNUM=? | OK |

8.7.3 Defined values :

<alphax> optional alphanumeric string associated with <numberx>
<numberx> string type phone number with format as specified by <typex>
<typex> type of address byte in integer format

8.8 Avoid phonebook init +WAIP

8.8.1 Description :

This specific command allows the initialization of all phonebooks to be inhibited during subsequent boots.

8.8.2 Syntax :

Command syntax : AT+WAIP=<mode>

| Command | Possible responses |
|--|--|
| AT+WAIP? <i>Note : Current values ?</i> | +WAIP : 0 OK <i>Note : Default value (init phonebooks)</i> |
| AT+WAIP=? <i>Note : Possible values ?</i> | +WAIP : (0,1) OK <i>Note : Disable / enable</i> |
| AT+WAIP =1 <i>Note : Inhibit initialization of phonebooks (next boot)</i> | OK <i>Note : no answer</i> |
| AT&W <i>Note : Save modifications in EEPROM</i> | |

Caution:

the given value should be stored in EEPROM. Therefore, the AT&W command must be used to save the new <mode> value.

Note:

No phonebook commands are allowed if +WAIP=1 (after boot).

If a phonebook command is entered, a "+CME ERROR: 3" is returned.

8.8.3 Defined values :

<mode>

0: Normal initialization (with phonebooks)

1: No phonebook initialization

8.9 Delete Calls Phonebook +WDCP

8.9.1 Description :

This specific command allows to delete the calls listed in some phonebooks.

8.9.2 Syntax :

Command syntax : AT+WDCP=<calls phonebook>

| Command | Possible responses |
|---|--|
| AT+WDCP? | OK |
| AT+WDCP=? <i>Note : Possible values ?</i> | +WDCP : ("LD","MC","RC") OK <i>Note : Identifiers of the phonebooks supporting a list of calls</i> |
| AT+WDCP="LD" <i>Note : Delete all the content of Last Dialing phonebook.</i> | OK <i>Note : Last Dialing phonebook is now empty.</i> |

8.9.3 Defined values :

<calls phonebook>

"LD": SIM (ME extended) Last dialing phonebook

"MC": ME missed calls list phonebook

"RC": ME received calls list phonebook

8.10 Set Voice Mail Number +CSVM

8.10.1 Description :

This commands allows to set/get and enable/disable the voice mail number in memory.

8.10.2 Syntax :

Command syntax : AT+CSVM=<mode>[,<number>[,<type>]]

| Command | Possible responses |
|---|--|
| AT+CSVM? <i>Note : Get mail number</i> | +CSVM: 1,"660",129 OK <i>Note : Voice mail number "660" is activated</i> |
| AT+CSVM=? <i>Note : Possible values ?</i> | +CSVM: (0-1),(129,145) OK <i>Note : activation/deactivation and format 129 & 145 are supported</i> |
| AT+CSVM=0,"888",129 <i>Note : Disable Voice Mail number and change value to "888".</i> | OK |

8.10.3 Defined values :

<mode>

0: Disable the voice mail number

1: Enable the voice mail number

<number>

Phone number in ASCII format.

<type>

TON/NPI (Type of address byte in integer format).

Note :

For the <type> parameter, all values are allowed from 0 to 255, but the MSB will be set to 1 in all cases (ex : a <type> value of 17 will be written as 145).

9 Short Messages commands

9.1 Parameters definition

| | |
|----------|---|
| <da> | Destination Address, coded like GSM 03.40 TP-DA |
| <dcs> | Data Coding Scheme, coded like in document [5]. |
| <dt> | Discharge Time in string format : "yy/MM/dd, hh :mm :ss±zz"(Year [00-99], Month [01-12], Day [01-31], Hour, Minute, Second and Time Zone [quarters of an hour]) |
| <fo> | First Octet, coded like SMS-SUBMIT first octet in document [4], default value is 17 for SMS-SUBMIT |
| <index> | Place of storage in memory. |
| <length> | Text mode (+CMGF=1): number of characters PDU mode (+CMGF=0): length of the TP data unit in octets |
| <mem1> | Memory used to list, read and delete messages (+CMGL, +CMGR and +CMGD). |
| <mem2> | Memory used to write and send messages (+CMGW, +CMSS). |
| <mid> | CBM Message Identifier. |
| <mr> | Message Reference. |
| <oa> | Originator Address. |
| <pid> | Protocol Identifier. |
| <pdu> | For SMS : GSM 04.11 SC address followed by GSM 03.40 TPDU in hexadecimal format, coded as specified in doc [4] For CBS : GSM 03.41 TPDU in hexadecimal format |
| <ra> | Recipient Address. |
| <sca> | Service Center Address |
| <scts> | Service Center Time Stamp in string format : "yy/MM/dd, hh :mm :ss±zz" (Year/Month/Day,Hour:Min:Seconds±TimeZone) |
| <sn> | CBM Serial Number |
| <st> | Status of a SMS-STATUS-REPORT |
| <stat> | Status of message in memory. |
| <tooa> | Type-of-Address of <oa>. |
| <tora> | Type-of-Address of <ra>. |
| <tosca> | Type-of-Address of <sca>. |
| <total1> | Number of message locations in <mem1>. |
| <total2> | Number of messages locations in <mem2>. |
| <used1> | Total number of messages locations in <mem1>. |
| <used2> | Total number of messages locations in <mem2>. |
| <vp> | Validity Period of the short message, default value is 167 |

9.2 Select message service +CSMS

9.2.1 Description :

The supported services are originated (SMS-MO) and terminated short message (SMS-MT) + Cell Broadcast Message (SMS-CB) services.

9.2.2 Syntax :

Command syntax : AT+CSMS=<service>

| Command | Possible responses |
|---|---|
| AT+CSMS=0 <i>Note : SMS AT command Phase 2 version 4.7.0</i> | +CSMS: 1,1,1 OK <i>Note : SMS-MO, SMS-MT and SMS-CB supported</i> |
| AT+CSMS=1 <i>Note : SMS AT command Phase 2 +</i> | +CSMS: 1,1,1 <i>Note : SMS-MO, SMS-MT and SMS-CB supported</i> |
| AT+CSMS? <i>Note : Current values ?</i> | +CSMS: 0,1,1,1 OK <i>Note : GSM 03.40 and 03.41 (SMS AT command Phase 2 version 4.7.0</i> |
| AT+CSMS=? <i>Note : Possible services</i> | +CSMS: (0,1) OK |

9.2.3 Defined values :

<service>

0: SMS AT commands are compatible with GSM 07.05 Phase 2 version 4.7.0.

1: SMS AT commands are compatible with GSM 07.05 Phase 2 + version .

9.3 New Message Acknowledgement +CNMA

9.3.1 Description :

This command allows reception of a new message routed directly to the TE to be acknowledged.

In TEXT mode, only positive acknowledgement to the network (RP-ACK) is possible.

In PDU mode, either positive (RP-ACK) or negative (RP-ERROR) acknowledgement to the network is possible.

Acknowledge with +CNMA is possible only if the +CSMS parameter is set to 1 (+CSMS=1) when a +CMT or +CDS indication is shown (see +CNMI command).

If no acknowledgement is given within the network timeout, an RP-ERROR is sent to the network, the <mt> and <ds> parameters of the +CNMI command are then reset to zero (do not show new message indication).

9.3.2 Syntax :

Command syntax in text mode :
AT+CNMA

Command syntax in PDU mode :
AT+CNMA [= <n> [, <length> [<CR>
PDU is entered <ctrl-Z / ESC>]]]

Note:

PDU is entered using <ackpdu> format instead of <pdu> format (e.g.. SMSC address field is not present).

Example of acknowledgement of a new message in TEXT mode

| Command | Possible responses |
|---|---|
| AT+CMGF=1 <i>Note : Set TEXT mode</i> | OK <i>Note : TEXT mode valid</i> |
| AT+CNMI=2,2,0,0,0 <i>Note : <mt>=2</i> | OK |
| | +CMT : "123456", "98/10/01,12 :30 00+00", 129,4 ,32,240, "15379", 129,5<CR><LF> Received message <i>Note : message received</i> |
| AT+CNMA <i>Note : acknowledge the message received</i> | OK <i>Note : send positive acknowledgement to the network</i> |
| AT+CNMA <i>Note : try to acknowledge again</i> | +CMS ERROR : 340 <i>Note : no +CNMA acknowledgment expected</i> |

Example of acknowledgement of a new message in PDU mode:

| Command | Possible responses |
|--|---|
| AT+CMGF=0 <i>Note : Set PDU mode</i> | OK <i>Note : PDU mode valid</i> |
| | +CMT: ,29 07913366003000F1240B913366920547 F30000003003419404800B506215D42E CFE7E17319 <i>Note : message received</i> |
| AT+CNMA=2,<length> <CR> ... Pdu message ... <Ctrl-Z/ESC> <i>Note : negative acknowledgement for the message.</i> | OK <i>Note : send a negative acknowledgement to the network (RP-ERROR) with PDU message (<ackpdu> format).</i> |

9.3.3 Defined values :

<n> : Type of acknowledgement in PDU mode

0: send RP-ACK without PDU (same as TEXT mode)

1: send RP-ACK with optional PDU message

2: send RP-ERROR with optional PDU message

<length>: Length of the PDU message

9.4 Preferred Message Storage +CPMS

9.4.1 Description :

This command allows the message storage area to be selected (for reading, writing, etc).

9.4.2 Syntax :

Command syntax : AT+CPMS=<mem1>,[<mem2>]

| Command | Possible responses |
|--|--|
| AT+CPMS=? <i>Note : Possible message storages</i> | +CPMS: ("SM","BM","SR"),("SM") OK <i>Note : Read, list, delete: SMS, CBM or SMS Status Report Write, send: SMS</i> |
| AT+CPMS? <i>Note : Read</i> | +CPMS: "SM",3,10,"SM",3,10 OK <i>Note : Read, write...SMS from/to SIM 3 SMS are stored in SIM. 10 is the total memory available in SIM</i> |
| AT+CPMS="AM" <i>Note : Select false message storage</i> | +CMS ERROR: 302 |
| AT+CPMS="BM" <i>Note : Select CBM message storage</i> | +CPMS: 2,20,3,10 OK <i>Note : Read, list, delete CBM from RAM 2 CBM are stored in RAM</i> |
| AT+CPMS? <i>Note : Read</i> | +CPMS: "BM",2,20,"SM",3,10 OK <i>Note : Read list, delete CBM from RAM Write SMS to SIM</i> |

9.4.3 Defined values :

<mem1>: Memory used to list, read and delete messages. It can be:

- "SM": SMS message storage in SIM (default)
- "BM": CBM message storage (in volatile memory).
- "SR" : Status Report message storage (in SIM if the EF-SMR file exists, otherwise in the ME non volatile memory)

Note :

"SR" ME non volatile memory is cleared when another SIM card is inserted. It is kept, even after a reset, while the same SIM card is used.

<mem2>: Memory used to write and send messages

- "SM" : SMS message storage in SIM (default).

If the command is correct, the following message indication is sent:

+CPMS: <used1>,<total1>,<used2>,<total2>

When <mem1> is selected, all following +CMGL, +CMGR and +CMGD commands are related to the type of SMS stored in this memory.

9.5 Preferred Message Format +CMGF

9.5.1 Description :

The message formats supported are *text mode* and *PDU mode*.

In PDU mode, a complete SMS Message including all header information is given as a binary string (in hexadecimal format). Therefore, only the following set of characters is allowed: {'0','1','2','3','4','5','6','7','8','9','A','B','C','D','E','F'}. Each pair of characters is converted to a byte (e.g.: '41' is converted to the ASCII character 'A', whose ASCII code is 0x41 or 65).

In Text mode, all commands and responses are in ASCII characters.

The format selected is stored in EEPROM by the +CSAS command.

9.5.2 Syntax :

Command syntax : AT+CMGF

| Command | Possible responses |
|--|---|
| AT+CMGF ? <i>Note : Current message format</i> | +CMGF: 1 OK <i>Note : Text mode</i> |
| AT+CMGF=? <i>Note : Possible message format</i> | +CMGF: (0-1) OK <i>Note : Text or PDU modes are available</i> |

Example, sending an SMS Message in PDU mode

| Command | Possible responses |
|--|--|
| AT+CMGF=0 <i>Note : Set PDU mode</i> | OK <i>Note : PDU mode valid</i> |
| AT+CMGS=14<CR> 0001030691214365000004C9E9340B <i>Note : Send complete MSG in PDU mode, no SC address</i> | +CMGS: 4 OK <i>Note : MSG correctly sent, <mr> is returned</i> |

9.5.3 Defined values :

The <pdu> message is composed of the SC address (« 00 means no SC address given, use default SC address read with +CSCA command) and the TPDU message.

In this example, the length of octets of the TPDU buffer is 14, coded as GSM 03.40

In this case the TPDU is : 0x01 0x03 0x06 0x91 0x21 0x43 0x65 0x00 0x00 0x04 0xC9 0xE9 0x34 0x0B, which means regarding GSM 03.40 :

| | |
|-------------------|---|
| <fo> | 0x01 (SMS-SUBMIT, no validity period) |
| <mr> (TP-MR) | 0x03 (Message Reference) |
| <da> (TP-DA) | 0x06 0x91 0x21 0x43 0x65 (destination address +123456) |
| <pid> (TP-PID) | 0x00 (Protocol Identifier) |
| <dc> (TP-DCS) | 0x00 (Data Coding Scheme : 7 bits alphabet) |
| <length> (TP-UDL) | 0x04 (User Data Length, 4 characters of text) |
| TP-UD | 0xC9 0xE9 0x34 0x0B (User Data : ISSY) |

TPDU in hexadecimal format must be converted into two ASCII characters, e.g. octet with hexadecimal value 0x2A is presented to the ME as two characters '2' (ASCII 50) and 'A' (ASCII 65).

9.6 Save Settings +CSAS

9.6.1 Description :

All settings specified by the +CSCA and +CSMP commands are stored in EEPROM if the SIM card is a Phase 1 card or in the SIM card if it is a Phase 2 SIM card.

9.6.2 Syntax :

Command syntax : AT+CSAS

| Command | Possible responses |
|---|--------------------------------------|
| AT+CSAS <i>Note : Store +CSAS and +CSMP parameters</i> | OK <i>Note : Parameters saved</i> |

9.7 Restore settings +CRES

9.7.1 Description :

All settings specified in the +CSCA and +CSMP commands are restored from EEPROM if the SIM card is Phase 1 or from the SIM card if it is a Phase 2 SIM card.

9.7.2 Syntax :

Command syntax : AT+CRES

| Command | Possible responses |
|---|---|
| AT+CRES <i>Note : Restore +CSAS and +CSMP parameters</i> | OK <i>Note : Parameters restored</i> |

9.8 Show text mode parameters +CSDH

9.8.1 Description :

This command gives additional information on text mode result codes. This information is given in brackets in the +CMTI, +CMT, +CDS, +CMGR, +CMGL commands.

9.8.2 Syntax :

Command syntax : AT+CSDH

| Command | Possible responses |
|---|---|
| AT+CSDH? <i>Note : Current value</i> | +CSDH: 0 OK <i>Note : Do not show header values</i> |

9.9 New message indication +CNMI

9.9.1 Description :

This command selects the procedure for message reception from the network.

9.9.2 Syntax :

Command syntax : AT+CNMI=<mode>,<mt>,<bm>,<ds>,<bfr>

| Command | Possible responses |
|---|--|
| AT+CNMI=2,1,0,0,0 <i>Note : <mt>=1</i> | OK |
| | AT+CMTI : "SM",1 <i>Note : message received</i> |
| AT+CNMI=2,2,0,0,0 <i>Note : <mt>=2</i> | OK |
| | +CMT : "123456","98/10/01,12 :30 00+00",129,4 ,32,240, "15379",129,5<CR><LF> message received <i>Note : message received</i> |
| AT+CNMI=2,0,0,1,0 <i>Note : <ds>=1</i> | OK |
| AT+CMGS="+33146290800"<CR> Message to send <ctrl-Z> <i>Note : Send a message in text mode</i> | +CMGS : 7 OK <i>Note : Successful transmission</i> |
| | +CDS : 2, 116, "+33146290800", 145, "98/10/01,12 :30 :07+04", "98/10/01 12 :30 :08+04", 0 <i>Note : message was correctly delivered</i> |

9.9.3 Defined values :

<mode> : controls the processing of unsolicited result codes

Only <mode>=2 is supported.

Any other value for <mode> (0,1 or 3) is accepted (return code will be *OK*), but the processing of unsolicited result codes will be the same as with <mode>=2.

<mode>

0: Buffer unsolicited result codes in the TA. If TA result code buffer is full, indications can be buffered in some other place or the oldest indications may be discarded and replaced with the new received indications

1: Discard indication and reject new received message unsolicited result codes when TA-TE link is reserved. Otherwise forward them directly to the TE

2: Buffer unsolicited result codes in the TA when TA-TE link is reserved and flush them to the TE after reservation. Otherwise forward them directly to the TE

3: Forward unsolicited result codes directly to the TE. TA-TE link specific inband used to embed result codes and data when TA is in on-line data mode

<mt> : sets the result code indication routing for SMS-DELIVERs. Default is 0.

<mt>

0: No SMS-DELIVER indications are routed.

1: SMS-DELIVERs are routed using unsolicited code : +CMTI: "SM", <index>

2: SMS-DELIVERs (except class 2 messages) are routed using unsolicited code : +CMT : [<alpha>,<length> <CR> <LF> <pdu> (PDU mode) or +CMT : <oa>,<alpha>,<scts> [<tooa>,<fo>,<pid>,<dcsc>,<sca>,<tosca>,<length>] <CR><LF><data> (text mode)

3: Class 3 SMS-DELIVERs are routed directly using code in <mt>=2 ; Message of other classes result in indication <mt>=1

<bm> : set the rules for storing received CBMs (Cell Broadcast Message) types depend on its coding scheme, the setting of Select CBM Types (+CSCB command) and <bm>. Default is 0.

<bm>

0: No CBM indications are routed to the TE. The CBMs are stored.

1: The CBM is stored and an indication of the memory location is routed to the customer application using unsolicited result code: +CBMI: "BM", <index>

2: New CBMs are routed directly to the TE using unsolicited result code. +CBM : <length><CR><LF><pdu> (PDU mode) or

+CBM : <sn>,<mid>,<dcsc>,<page>,<pages>(Text mode) <CR><LF> <data>

3: Class 3 CBMs : as <bm>=2. Other classes CBMs : as <bm>=1.

<ds> for SMS-STATUS-REPORTs. Default is 0.

<ds>

0: No SMS-STATUS-REPORTs are routed.

1: SMS-STATUS-REPORTs are routed using unsolicited code : +CDS : <length> <CR> <LF> <pdu> (PDU mode) or +CDS : <fo>,<mr>,<ra>,<tora>,<scts>,<dt>,<st> (Text mode)

2: SMS-STATUS-REPORTs are stored and routed using the unsolicited result code : +CDSI: "SR", <index>

<bfr> Default is 0.

<bfr>

0: TA buffer of unsolicited result codes defined within this command is flushed to the TE when <mode> 1...3 is entered (OK response shall be given before flushing the codes)

1: TA buffer of unsolicited result codes defined within this command is cleared when <mode> 1...3 is entered.

9.10 Read message +CMGR

9.10.1 Description :

This command allows the application to read stored messages. The messages are read from the memory selected by +CPMS command.

9.10.2 Syntax :

Command syntax : AT+CMGR=<index>

Response syntax for text mode:

+CMGR :<stat>,<oa>,[<alpha>,<fo>,<pid>,<dcs>,<sca>,<tosca>,<length>] <CR><LF> <data> (for **SMS-DELIVER** only)

+CMGR : <stat>,<da>,[<alpha>,<fo>,<pid>,<dcs>,<vp>], <sca>,<tosca>,<length>] <CR><LF> <data> (for **SMS-SUBMIT** only)

+CMGR : <stat>,<fo>,<mr>,[<ra>],[<tora>],<scts>,<dt>,<st> (for **SMS-STATUS-REPORT** only)

Response syntax for PDU mode :

+CMGR: <stat> , [<alpha>] ,<length> <CR><LF> <pdu>

A message read with status "REC UNREAD" will be updated in memory with the status "REC READ".

Note :

the <stat> parameter for SMS Status Reports is always "READ".

Example :

| Command | Possible responses |
|--|--|
| | AT+CMTI: "SM",1 <i>Note : New message received</i> |
| AT+CMGR=1 <i>Note : Read the message</i> | +CMGR: "REC UNREAD","0146290800", "98/10/01,18 :22 :11+00",<CR><LF> ABCdefGHI OK |
| AT+CMGR=1 <i>Note : Read the message again</i> | +CMGR: "REC UNREAD","0146290800", "98/10/01,18 :22 :11+00",<CR><LF> ABCdefGHI OK <i>Note : Message is read now</i> |
| AT+CMGR=2 <i>Note : Read at a wrong index</i> | +CMS ERROR: 321 <i>Note : Error : invalid index</i> |
| AT+CMGF=0 ;+CMGR=1 <i>Note : In PDU mode</i> | +CMGR: 2,,<length> <CR><LF><pdu> OK <i>Note : Message is stored but unsent, no <alpha>field</i> |
| AT+CMGF=1;+CPMS="SR";+CNMI=,,,2 <i>Reset to text mode, set read memory to "SR", and allow storage of further SMS Status Report into "SR" memory</i> | OK |
| AT+CMSS=3 <i>Send an SMS previously stored</i> | +CMSS: 160 OK |
| | +CDSI: "SR",1 <i>New SMS Status Report stored in "SR" memory at index 1</i> |
| AT+CMGR=1 <i>Read the SMS Status Report</i> | +CMGR: "READ",6,160, "+33612345678",129,"01/05/31,15:15:09 +00", "01/05/31,15:15:09+00",0 OK |

9.11 List message +CMGL

9.11.1 Description :

This command allows the application to read stored messages, by indicating the type of the message to read. The messages are read from the memory selected by the +CPMS command.

9.11.2 Syntax :

Command syntax : AT+CMGL=<stat>

Response syntax for text mode:

+CMGL : <index>,<stat>,<da/oa>[,<alpha>], [<scts>,<tooa/toda>,<length>]
<CR><LF><data> (for **SMS-DELIVER** and **SMS-SUBMIT**, may be followed by other <CR><LF>+CMGL:<index>...)

+CMGL : <index>,<stat>,<fo>,<mr>,[<ra>],[<tora>],<scts>,<dt>,<st> (for **SMS-STATUS-REPORT** only, may be followed by other <CR><LF>+CMGL:<index>...)

Response syntax for PDU mode :

+CMGL : <index>,<stat>,[<alpha>], <length> <CR><LF> <pdu> (for **SMS-DELIVER**, **SMS-SUBMIT** and **SMS-STATUS-REPORT**, may be followed by other <CR><LF>+CMGL:<index>...)

| Command | Possible responses |
|--|---|
| AT+CMGL="REC UNREAD" <i>Note : List unread messages in text mode</i> | +CMGL: 1,"REC UNREAD","0146290800", <CR><LF> Unread message ! +CMGL: 3,"REC UNREAD", "46290800", <CR><LF> <i>Another message unread!</i> OK <i>Note : 2 messages are unread, these messages will then have their status changed to "REC READ" (+CSDH:0)</i> |
| AT+CMGL="REC READ" <i>Note : List read messages in text mode</i> | +CMGL: 2,"REC READ","0146290800", <CR><LF> Keep cool OK |
| AT+CMGL="STO SENT" <i>Note : List stored and sent messages in text mode</i> | OK <i>Note : No message found</i> |
| AT+CMGL=1 <i>Note : List read messages in PDU mode</i> | +CMGL: 1,1,,26 <CR><LF> 07913366003000F3040B913366920547 F40013001190412530400741AA8E5A9C 5201 OK |

9.11.3 Defined values

<stat> possible values (status of messages in memory) :

| Text mode possible values | PDU mode possible values | Status of messages in memory |
|---------------------------|--------------------------|------------------------------|
| "REC UNREAD" | 0 | received unread messages |
| "REC READ" | 1 | received read messages |
| "STO UNSENT" | 2 | stored unsent messages |
| "STO SENT" | 3 | stored sent messages |
| "ALL" | 4 | all messages |

Note :

For SMS Status Reports, only "ALL" / 4 and "READ" / 1 values of the <stat> parameter will list messages ; other values will only return OK.

9.12 Send message +CMGS

9.12.1 Description :

The <address> field is the address of the terminal to which the message is sent. To send the message, simply type, <ctrl-Z> character (ASCII 26). The text can contain all existing characters except <ctrl-Z> and <ESC> (ASCII 27). This command can be aborted using the <ESC> character when entering text. In PDU mode, only hexadecimal characters are used ('0'...'9','A'...'F').

9.12.2 Syntax :

Command syntax in text mode :

AT+CMGS= <da> [,<toda>] <CR>

text is entered <ctrl-Z / ESC >

Command syntax in PDU mode :

AT+CMGS= <length> <CR>

PDU is entered <ctrl-Z / ESC >

| Command | Possible responses |
|--|--|
| AT+CMGS=" +33146290800" <CR> Please call me soon, Fred. <ctrl-Z> <i>Note : Send a message in text mode</i> | +CMGS: <mr> OK <i>Note : Successful transmission</i> |
| AT+CMGS=<length><CR><pdu><ctrl-Z> <i>Note : Send a message in PDU mode</i> | +CMGS: <mr> OK <i>Note : Successful transmission</i> |

The message reference, <mr>, which is returned to the application is allocated by the product. This number begins with 0 and is incremented by one for each outgoing message (successful and failure cases); it is cyclic on one byte (0 follows 255).

Note:

this number is not a storage number – outgoing messages are not stored.

9.13 Write Message to Memory +CMGW

9.13.1 Description :

This command stores a message in memory (either SMS-SUBMIT or SMS-DELIVERS). The memory location <index> is returned (no choice possible as with phonebooks +CPBW).

Text or PDU is entered as described for the Send Message +CMGS command.

9.13.2 Syntax :

Command syntax in text mode : (<index> is returned in both cases)

AT+CMGW= <oa/da> [,<tooa/toda> [,<stat>]] <CR>

enter text <ctrl-Z / ESC>

Command syntax in PDU mode :

AT+CMGW= <length> [,<stat>] <CR>

give PDU <ctrl-Z / ESC>

Response syntax:

+CMGW: <index> or +CMS ERROR: <err> if writing fails

| Command | Possible responses |
|---|---|
| AT+CMGW="+33146290800"<CR> Hello how are you ?<ctrl-Z> <i>Note : Write a message in text mode</i> | +CMGW: 4 OK <i>Note : Message stored in index 4</i> |
| AT+CMGW=<length><CR><pdu><ctrl-Z> <i>Note : Write a message in PDU mode</i> | +CMGW: <index> OK <i>Note : Message stored in <index></i> |

9.13.3 Defined values :

Parameter Definition :

<oa/da> : Originating or Destination Address Value in string format.

<tooa/toda> : Type of Originating / Destination Address.

<stat> : Integer type in PDU mode (*default 2 for +CMGW*), or string type in text mode (*default "STO UNSENT" for +CMGW*). Indicates the status of message in memory. If <stat> is omitted, the stored message is considered as a message to send.

<stat>

0: "REC UNREAD"

1: "REC READ"

2: "STO UNSENT"

3: "STO SENT"

<length> : Length of the actual data unit in octets

9.14 Send Message From Storage +CMSS

9.14.1 Description :

This command sends a message stored at location value <index>.

9.14.2 Syntax :

Command syntax: AT+CMSS=<index>[,<da> [,<toda>]]

Response syntax:

+CMSS : <mr> or +CMS ERROR: <err> if sending fails

If a new recipient address <da> is given, it will be used instead of the one stored with the message

| Command | Possible responses |
|---|---|
| AT+CMGW=0660123456<CR> Today is my birthday <i>Note :</i> | +CMGW : 5 OK <i>Note :Message stored with index 5</i> |
| AT+CMSS=5, 0680654321 <i>Note : Send the message 5 to a different destination number</i> | +CMSS :<mr> OK <i>Note : Successful transmission</i> |
| AT+CMSS=5, 0680654321 <i>Note : Send the message 5 to a different destination number</i> | +CMSS :<mr> OK <i>Note : Successful transmission</i> |

9.15 Set Text Mode Parameters +CSMP

9.15.1 Description :

This command is used to select a value for <vp>, <pid>, and <dc>.

9.15.2 Syntax ;

Command syntax : AT+CSMP=<fo>, <vp>, <pid>,<dc>

| Command | Possible responses |
|--|---|
| AT+CSMP? <i>Note : current values</i> | +CSMP: 0,0,0,0 OK <i>Note : No validity period <dc>= PCCP437 alphabet (8 bits → 7 bits)</i> |
| AT+CSMP=17,23,64,244 <i>Note :<vp> = 23 (2 hours, relative format) <dc> = GSM 8 bits alphabet</i> | OK <i>Note : Command correct</i> |

9.15.3 Defined values :

The <fo> byte comprises 6 different fields :

| | | | | | | | |
|----|-----|-----|-----|----|----|-----|----|
| b7 | b6 | B5 | b4 | b3 | b2 | b1 | b0 |
| RP | UDH | SRR | VPF | | RD | MTI | |
| | I | | | | | | |

RP : Reply Path, not used in text mode.

UDHI : User Data Header Information, b6=1 if the beginning of the User Data field contains a Header in addition to the short message. This option is not supported in +CSMP command, but can be used in PDU mode (+CMGS).

SRR : Status Report Request, b5=1 if a status report is requested. This mode is supported.

VPF : Validity Period Format

b4=0 & b3=0 -> <vp> field is not present

b4=1 & b3=0 -> <vp> field is present in relative format

Others formats (absolute & enhanced) are not supported.

RD : Reject Duplicates, b2=1 to instruct the SC to reject an SMS-SUBMIT for an SM still held in the SC which has the same <mr> and the same <da> as the previously submitted SM from the same <oa>.

MTI : Message Type Indicator

b1=0 & b0=0 -> SMS-DELIVER (in the direction SC to MS)

b1=0 & b0=1 -> SMS-SUBMIT (in the direction MS to SC)

In text mode <vp> is only coded in "relative" format. The default value is 167 (24 hours). This means that one octet can describe different values :

| VP value | Validity period value |
|------------|---------------------------------------|
| 0 to 143 | (VP + 1) x 5 minutes (up to 12 hours) |
| 144 to 167 | 12 hours + (VP - 143) x 30 minutes) |
| 168 to 196 | (VP - 166) x 1 day |
| 197 to 255 | (VP - 192) x 1 week |

<pid> is used to indicate the higher layer protocol being used or indicates interworking with a certain type of telematic device. For example, 0x22 is for group 3 telefax, 0x24 is for voice telephone, 0x25 is for ERMES.

<dcs> is used to determine the way the information is encoded. Compressed text is not supported. Only GSM default alphabet, 8 bit data and UCS2 alphabet are supported.

9.16 Delete message +CMGD

9.16.1 Description :

This command is used to delete one or several messages from preferred message storage ("BM" SMS CB 'RAM storage', "SM" SMSPP storage 'SIM storage' or "SR" SMS Status-Report storage).

9.16.2 Syntax :

Command syntax : AT+CMGD=<Index> [,<DelFalg>]

| Command | Possible responses |
|-------------------------------|---|
| | +CMTI:"SM",3 Note : New message received |
| AT+CMGR=3 Note : Read it | +CMGR: "REC UNREAD","0146290800", "98/10/01,18 :19 :20+00" <CR><LF> Message received! Note : Unread message received from 0146290800 on the 01/10/1998 at 18H19m 20s |
| AT+CMGD=3 Note : Delete it | OK Note : Message deleted |
| AT+CMGD=1,0 | OK Note : The message from the preferred message storage at the location 1 is deleted |
| AT+CMGD=1,1 | OK Note : All READ messages from the preferred message storage are deleted |
| AT+CMGD=1,2 | OK Note : All READ messages and SENT mobile originated messages are deleted |
| AT+CMGD=1,3 | OK Note : All READ, SENT and UNSENT messages are deleted |
| AT+CMGD=1,4 | OK Note : All messages are deleted |

9.16.3 Defines values

<index>

(1-20)

When the preferred message storage is "BM"
Integer type values in the range of location numbers of SIM
Message memory when the preferred message storage is "SM"
or "SR".

<DelFlag>

0

Delete message at location <index>.

1

Delete All READ messages

2

Delete All READ and SENT messages

3

Delete All READ, SENT and UNSENT messages

4

Delete All messages.

Note :

when the preferred message storage is "SR", as SMS status reports are
assumed to have a "READ" status, if <DelFlag> is greater than 0, all SMS
status reports will be deleted.

9.17 Service center address +CSCA

9.17.1 Description

This command is used to indicate which service center the message must be sent to.

The product has no default value for this address. If the application tries to send a message without having indicated the service center address, an error will be generated.

Therefore, the application must indicate the SC address when initialising the SMS. This address is then permanently valid. The application may change it if necessary.

9.17.2 Syntax :

Command syntax : AT+CSCA

| Command | Possible responses |
|--|---|
| AT+CMGS= "+33146290800"<CR> Hello, how are you?<ctrl-Z> <i>Note : Send a message</i> | +CMS ERROR: 330 <i>Note : service center unknown</i> |
| AT+CSCA="0696741234" <i>Note : Service center initialization</i> | OK <i>Note :</i> |
| AT+CMGS=" +33146290800"<CR> Happy Birthday ! <ctrl-Z> <i>Note :</i> | +CMGS: 1 OK <i>Note : Successful transmission</i> |

9.18 Select Cell Broadcast Message Types +CSCB

9.18.1 Description :

This command selects which types of CBMs are to be received by the ME, This command is allowed in both PDU and text modes.

9.18.2 Syntax :

Command syntax : AT+CSCB= <mode>, [<mids>, [<dcss>]]

The <bm> parameter of +CNMI command controls the message indication.

Test read command (AT+CSCB ?) is not supported.

The activation of CBM reception (<mode>=0) can select only specific Message Identifiers (list in <mids>) for specific Languages (list in <dcss>), but the deactivation stops any reception of CBMs (only AT+CSCB=1 is allowed) Message Identifiers (<mids> parameter) indicates which type of message identifiers the ME should listen to.

Supported languages (<dcss> parameter) are : 0 for German, 1 for English, 2 for Italian, 3 for French, 4 for Spanish, 5 for Dutch, 6 for Swedish, 7 for Danish, 8 for Portuguese, 9 for Finnish, 10 for Norwegian, 11 for Greek, 12 for Turkish, 13 for Hungarian, 14 for Polish and 32 for Czech.

| Command | Possible responses |
|--|---|
| AT+CSCB=0,"15-17,50,86","" <i>Note : Accept SMS-CB types, 15,16,17,50 and 86 in any language</i> | OK <i>Note : CBMs can be received</i> |
| +CBM : 10<CR><LF> 00112233445566778899 <i>Note : CBM length of a received Cell Broadcast message (SMS-CB), CBM bytes in PDU mode</i> | AT+CSCB=1 <i>Note : Deactivate the reception of CBMs</i> |
| AOK <i>Note : CBM reception is completely stopped</i> | |

9.19 Cell Broadcast Message Identifiers +WCBM

9.19.1 Description :

This specific command is used to read the EF-CBMI SIM file.

Remark: The EF-CBMI file is not used with the +CSCB command.

The application should read this file (using AT+WCBM ?) and combine the Message Identifiers with those required by the application.

9.19.2 Syntax :

Command syntax : AT+WCBM= <mids>

| Command | Possible responses |
|--|--|
| AT+WCBM="10,100,1000,10000" <i>Note : Write 4 messages identifiers in EF-CBMI</i> | OK <i>Note : CBMIs are stored in EF-CBMI</i> |
| AT+WCBM? <i>Note : Read the CBMIs in EF-CBMI</i> | +WCBM="10,100,1000,10000" OK <i>Note : 4 CBMIs are stored in EF-CBMI</i> |

9.20 Message status modification +WMSC

9.20.1 Syntax :

Command syntax : AT+WMSC= <loc>, <status>

<loc> location number of the stored message (integer)

<status> new status to be stored, as for +CMGL command :

| PDU Mode | Text Mode |
|----------|--------------|
| 0 | "REC UNREAD" |
| 1 | "REC READ" |
| 2 | "STO UNSENT" |
| 3 | "STO SENT" |

Possible responses:

| | |
|-----------------|---|
| OK | if the location is valid |
| +CMS ERROR: 321 | if <loc> is invalid or free |
| +CMS ERROR: 302 | if the new <status> and the previous one are incompatible (1) |

Note 1 :

The accepted status changes are from READ to NOT READ and vice versa, and from SENT to NOT SENT and vice versa.

If all the parameters are correct, the product overwrites the whole SMS in SIM. Only the first byte (Status byte) is changed.

9.21 Message overwriting +WMGO

9.21.1 Description :

The +CMGW command writes an SMS to the first location available. To write an SMS to a specified location, the +WMGO **specific** command forces the product to write an SMS (with the +CMGW command) to the location specified with +WMGO, but for just one +CMGW command.

9.21.2 Syntax :

Command syntax : AT+WMGO= <loc>

<loc> location number of the SIM record to write or overwrite

Possible responses:

| | |
|-----------------|--|
| OK | if <loc> is a valid SMS location, for AT+WMGO=? and for AT+WMGO? |
| +CMS ERROR: 321 | if <loc> is out of the SIM capacity range. |
| +WMGO: <loc> | for AT+WMGO? |

OK

On the next AT+CMGW command, the record number used will be the one specified by the AT+WMGO command. The location is forgotten and, in order to perform a second overwrite, +WMGO has to be used again.

If the external application specifies a free location, and if an incoming message is received before the AT+CMGW command, the product may store the incoming message at a location available. This could be the one specified by +WMGO (the product does not prevent from this). If the user then issues an AT+CMGW command without changing the AT+WMGO location, the new message will be overwritten!

Note that this location number is not kept over a software reset.

9.22 Unchange SMS Status +WUSS

9.22.1 Description :

The +WUSS command allows to keep the SMS Status to UNREAD after +CMGR or +CMGL.

9.22.2 Syntax :

Command syntax : AT+WUSS = <mode>

<mode> : 1 The SMS Status will not change.

<mode> : 0 The SMS Status will change.

Possible responses:

OK

10 Supplementary Services commands

10.1 Call forwarding +CCFC

10.1.1 Description :

This commands allows control of the "call forwarding" supplementary service.

10.1.2 Syntax :

Command syntax :

AT+CCFC= <reason>, <mode> [, <number> [,<type> [,<class> [,<subaddr> [, <satype> [,<time>]]]]]]

Response syntax:

+CCFC: <status>, <class1> [, <number>, <type> [,<subaddr>, <satype> [,<time>]]] [<CR><LF>+CCFC: <status>, <class2> [, <number>, <type> [,<subaddr>, <satype> [,<time>]]] [...]]

| Command | Possible responses |
|--|---|
| AT+CCFC=0,3,"0146290800" <i>Note : Register to an unconditional call forwarding</i> | OK <i>Note : Command valid</i> |
| AT+CCFC=0,2 <i>Note : Interrogate unconditional call forwarding</i> | +CCFC:1,1,"0146290800",129 <i>Note : Call forwarding active for voice</i> <CR><LF>+CCFC:1,2,"0146290802",129 <i>Note : Call forwarding active for data</i> <CR><LF>+CCFC:1,4,"0146290804",129 OK <i>Note : Call forwarding active for fax</i> |
| AT+CCFC=0,4 <i>Note : Erase unconditional call forwarding</i> | OK <i>Note : Command valid</i> |

+CCFC responses are not sorted by <class> parameter, but only by the order of network response.

10.1.3 Defined values

<reason>

- 0 Unconditional
- 1 Mobile busy
- 2 No reply
- 3 Not reachable
- 4 All call forwarding
- 5 All conditional call forwarding

<mode>

- 0 Disable
- 1 Enable
- 2 Interrogate
- 3 Registration
- 4 Erasure

<class>

- 1 Voice
- 2 Data
- 4 Fax
- 8 Short Messages
- 7 All classes

Note:

The combination of different classes is not supported, it will only result in the activation / deactivation / status request of all classes (7).

In the case where the FDN phonebook is activated, the registration is restricted to the phone numbers written in the FDN.

<subaddr> not managed
<satype> not managed
<time> For **<reason>** = 2 (No reply), 4 (all call forwarding) and 5 (all conditional call forwarding), time to wait (1 to 30) in seconds before call is forwarded. Default value is 20.

10.2 Call barring +CLCK

10.2.1 Description :

This command allows control of the call barring supplementary service. Locking, unlocking or querying the status of call barring is possible for all classes or for a specific class.

10.2.2 Syntax :

Command Syntax: AT+CLCK= <fac>, <mode> [, <password> [, <class>]]

Response Syntax: (for <mode>=2 and command successful)

+CLCK: <status> [, <class1> [<CR><LF>+CLCK: <status>, <class2> [...]]

| Command | Possible responses |
|--------------------------------------|--|
| AT+CLCK="AO",1,1234 <i>Note :</i> | OK <i>Note : Command valid</i> |
| AT+CLCK="AO",0,5555 <i>Note :</i> | +CME ERROR: 16 <i>Note : Wrong password</i> |
| AT+CLCK="AO",0,1234 <i>Note :</i> | OK <i>Note : Command valid</i> |

<fac>
 "AO", "OI", "OX" barring for outgoing calls
 "AI", "IR" barring for incoming calls
 "AG", "AC", "AB" for all calls barring (<mode>=0 only)

<mode>
 0: Unlocks the facility
 1: Locks the facility
 2: Query status

<class> : see description for +CLCK command (Facility lock) or +CCFC (Call forwarding).

A combination of different classes is **not supported**. It will only result in the activation / deactivation / status request for all classes (7).
 The password code is over 4 digits maximum.

10.3 Modify SS password +CPWD

10.3.1 Description :

This command is used by the application to change the supplementary service password.

10.3.2 Syntax :

Command Syntax: AT+CPWD=<fac>,<OldPassword>, <NewPassword>
 for <fac> see +CLCK command with only "P2" facility added (SIM PIN2).

| Command | Possible responses |
|--|--|
| AT+CPWD="AO",1234,5555 <i>Note : Change Call Barring password</i> | OK <i>Note : Password changed</i> |
| AT+CPWD="AO",1234,5555 <i>Note : Change password</i> | +CME ERROR: 16 <i>Note : Wrong password</i> |
| AT+CPWD="AO",5555,1234 <i>Note : Change password</i> | OK <i>Note : Password changed</i> |

Whatever the facility, the change of password applies to all call barring.

10.4 Call waiting +CCWA

10.4.1 Description :

This command allows control of the call waiting supplementary service.
 The product will send a +CCWA unsolicited result code when the call waiting service is enabled.

10.4.2 Syntax :

Command Syntax : AT+CCWA=<n>, [<mode> [, <class>]]

Response Syntax: (for <mode>=2 and command successful)

+CCWA: <status> [, <class1> [<CR><LF>+CCWA: <status>, <class2> [...]]

Unsolicited result: +CCWA: <number>, <type>, <class> [,<alpha>] (when waiting service is enabled)

| Command | Possible responses |
|--|--|
| AT+CCWA=1,1,1 <i>Note : Enable call waiting for voice calls</i> | OK <i>Note : Command valid</i> |
| AT+CCWA=1,2 <i>Note : Interrogate call waiting</i> | +CCWA:1,1 OK <i>Note : Call waiting active for voice calls</i> |
| +CCWA:"0146290800",145,1,"FREDDY" or +CCWA:"0146290800",145,1,"8023459678FFFF" (UCS2 format) <i>Note : Number and name of the waiting voice call</i> | <i>Note :</i> |
| AT+CCWA=1,0,7 <i>Note : Erase call waiting</i> | OK <i>Note : Command valid</i> |
| +CCWA:,,1 <i>Note : voice call waiting (no number)</i> | |

10.4.3 Defined values :

<n> : result code presentation status in the TA

<n>

0 : Disable

1 : Enable

<mode>

0 : Disable

1 : Enable

2 : Query status

<class>

1: Voice

2 : Data

3: Fax Short

4: Messages

5: All classes

A combination of different classes is **not supported**. It will only result in the activation / deactivation / status request for all classes (7).

<alpha> : optional string type alphanumeric representation of <number> corresponding to the entry found in the ADN or FDN phonebook.

10.5 Calling line identification restriction +CLIR

10.5.1 Description :

This command allows control of the calling line identification restriction supplementary service.

10.5.2 Syntax :

Command syntax : AT+CLIR=<n>

Response syntax : +CLIR :<n>,<m> (for AT+CLIR ?)

| Command | Possible responses |
|--|---|
| AT+CLIR=2 <i>Note :</i> | OK <i>Note : Command valid</i> |
| AT+CLIR ? <i>Note : Ask for current functionality</i> | +CLIR :<n>,<m> OK <i>Note : <n> and <m> as defined here-below</i> |

10.5.3 Defined values :

<n>: sets the line ID restriction for outgoing calls

<n>

0: Presentation indicator is used according to the subscription of the CLIR service

1: CLIR invocation

2: CLIR suppression

<m>: shows the subscriber CLIR status in the network

<m>

0: CLIR not provisioned

1: CLIR provisioned in permanent mode

2: Unknown (no network...)

3: CLIR temporary mode presentation restricted

4: CLIR temporary mode presentation allowed

10.6 Calling line identification presentation +CLIP

10.6.1 Description :

This command allows control of the calling line identification presentation supplementary service. When presentation of the CLI (Calling Line Identification) is enabled (and calling subscriber allows), +CLIP response is returned after every RING (or +CRING) result code.

10.6.2 Syntax :

Command syntax : AT+CLIP=<n>

Response syntax : +CLIP: <n>,<m> for AT+CLIP?

+CLIP: <number>, <type>[,<subaddr>, <satype>, <alpha>] for an incoming call, after each RING or +CRING indication

| Command | Possible responses |
|---|---|
| AT+CLIP=1 <i>Note : Enable CLIP</i> | OK <i>Note : CLIP is enabled</i> |
| AT+CLIP? <i>Note : Ask for current functionality</i> | +CLIP:<n>,<m> OK <i>Note : <n> and <m> defined as below</i> |
| | RING <i>Note : Incoming call</i> +CLIP: "0146290800",129,1,,,"FRED" or +CLIP: "0146290800",129,1,,,"8000204212FFFF" " (UCS2 format) <i>Note : Incoming call with number and name presentation</i> |
| AT+CLIP=0 <i>Note : Disable CLIP presentation</i> | OK <i>Note : Command valid</i> |

10.6.3 Defined values :

<n>: parameter sets/shows the result code presentation in the TA

<n>

0: Disable

1: Enable

<m>: parameter shows the subscriber CLIP service status in the network

<m>

0: CLIP not provisioned

1: CLIP provisioned

2: Unknown (no network...)

10.7 Connected line identification presentation +COLP

10.7.1 Description :

This command allows control of the connected line identification presentation supplementary service - useful for call forwarding of the connected line.

10.7.2 Syntax :

Command syntax: AT+COLP=<n>

Response syntax: +COLP: <n>,<m> for AT+COLP?

+COLP: <number>,<type> [,<subaddr>, <satype>, <alpha>]

after ATD command, before OK or CONNECT <speed>

| Command | Possible responses |
|---|--|
| AT+COLP=1 <i>Note : Activate COLP</i> | OK <i>Note : Command valid</i> |
| AT+COLP? <i>Note : Ask for current functionality</i> | +COLP:1,1 OK <i>Note : COLP is enabled and provisioned</i> |
| ATD146290928; <i>Note : Outgoing call</i> | +COLP:"0146290928",129,,,"JOE" or +COLP:"0146290800",129,1,,,"8000204212FFFF" (UCS2 format) OK <i>Note : Connected outgoing line number and name presentation</i> |
| AT+COLP=0 <i>Note : Deactivate COLP</i> | OK <i>Note : Command valid</i> |

10.7.3 Defined values

<n>: parameter sets/shows the result code presentation status in the TA

<n>

0: Disable

1: Enable

<m>: parameter shows the subscriber COLP service status in the network

<m>

0: COLP not provisioned

1: COLP provisioned

2: Unknown (no network)

10.8 Advice of charge +CAOC

10.8.1 Description :

This refers to the Advice of Charge supplementary service (GSM 02.24 and GSM 02.86) which enables the subscriber to obtain information on call cost. With <mode>=0, the command returns the current call meter value (CCM) from the ME.

If AOC is supported, the command can also enable unsolicited event reporting on CCM information.

The unsolicited result code +CCCM: <ccm> is sent when the CCM value changes. Deactivation of unsolicited event reporting is performed with the same command.

If AOC is supported, the Read command indicates whether unsolicited reporting is activated or not.

10.8.2 Syntax :

Command syntax : AT+CAOC= <mode>

| Command | Possible responses |
|---|--|
| AT+CAOC=0 <i>Note : Query CCM value</i> | +CAOC: "000A08" OK <i>Note : Display Current Call Meter value (CCM=2568)</i> |
| AT+CAOC=1 <i>Note : Deactivate unsolicited report of CCM value</i> | OK <i>Note : CCM report deactivated</i> |
| AT+CAOC=2 <i>Note : Activate unsolicited report of CCM value</i> | OK <i>Note : CCM report activated</i> |
| AT+CAOC ? <i>Note : Request mode</i> | +CAOC : <mode> OK <i>Note : Display unsolicited report mode (1 or 2)</i> |
| AT+CAOC=? <i>Note : Request supported modes</i> | +CAOC : (0-2) OK <i>Note : 0,1,2 modes supported</i> |

10.8.3 Defined values :

<mode>

0: query CCM value

1: deactivate the unsolicited reporting of CCM value

2: activate the unsolicited reporting of CCM value

<ccm> string type; three bytes of the current call meter value in hexadecimal format (e.g. "00001E" corresponds to the decimal value 30); value is in home units and bytes are coded in a similar way as the ACMmax value in SIM

10.9 Accumulated call meter +CACM

10.9.1 Description :

This command resets the Advice of Charge for accumulated call meter value in SIM file EF_{ACM}. The ACM contains the total number of home units for both the current and preceding calls. SIM PIN2 is required to reset the value. If setting fails in an ME error, +CME ERROR: <err> is returned.

The Read command returns the current value of the ACM.

The ACM value (entered or displayed) is in hexadecimal format with 6 digits.

10.9.2 Syntax :

Command syntax : AT+CACM

| Command | Possible responses |
|--|---|
| AT+CACM? <i>Note : Request ACM value</i> | +CACM: "000400" OK <i>Note : Display ACM value (ACM=1024)</i> |
| AT+CACM= 1234 <i>Note : Request ACM reset, real PIN2 is "1234"</i> | OK <i>Note : ACM value is reset</i> |
| AT+CACM= 0000 <i>Note : Request ACM reset with wrong PIN2 value</i> | +CME ERROR : 16 <i>Note : Incorrect password</i> |
| AT+CACM ? <i>Note : Request ACM value</i> | +CACM: "000000" OK <i>Note : Display ACM value (ACM = 0)</i> |

10.10 Accumulated call meter maximum +CAMM

10.10.1 Description :

The set command sets the Advice of Charge related to accumulated call meter maximum value in SIM file EF_{ACMmax}. ACMmax contains the maximum number of home units the subscriber is allowed to consume. When ACM (see +CACM) reaches ACMmax, calls are prohibited. SIM PIN2 is required to set the value. If setting fails in an ME error, +CME ERROR: <err> is returned.

The Read command returns the current value of ACMmax.

The ACMmax value (entered or displayed) is in hexadecimal format with 6 digits.

10.10.2 Syntax :

Command syntax : AT+CAMM

| Command | Possible responses |
|--|---|
| AT+CAMM="000400",1234 <i>Note : Request ACMmax update, PIN2 is "1234"</i> | OK <i>Note : ACMmax updated to 1024</i> |
| AT+CAMM="000400",0000 <i>Note : Request ACMmax update, PIN2 is "1234"</i> | +CME ERROR : 16 <i>Note : Incorrect password</i> |
| AT+CAMM ? <i>Note : Request ACMmax value</i> | +CAMM : "000400" OK <i>Note : ACMmax = 1024</i> |

10.11 Price per unit and currency table +CPUC

10.11.1 Description :

The set command sets the parameters for Advice of Charge related to price per unit and the currency table in SIM file EF_{PUCT}. PUCT information can be used to convert the home units (as used in +CAOC, +CACM and +CAMM) into currency units. SIM PIN2 is required to set the parameters. If setting fails in an ME error, +CME ERROR: <err> is returned.

10.11.2 Syntax :

Command syntax : AT+CPUC

| Command | Possible responses |
|---|--|
| AT+CPUC="FFR","0.82",1234 <i>Note : Request Currency and Price per unit update</i> | OK <i>Note :</i> |
| AT+CPUC="FFR","0.82",1111 <i>Note : Request Currency and PPU update (wrong PIN2)</i> | + CME ERROR : 16 <i>Note : Incorrect password</i> |
| AT+CPUC? <i>Note : Request Currency and Price</i> | +CPUC:"FFR","0.82" OK <i>Note : Currency= "FFR" Price per unit= "0.82"</i> |

10.12 Call related supplementary services +CHLD

10.12.1 Description :

This command is used to manage call hold and multiparty conversation (conference call). Calls can be put on hold, recovered, released or added to a conversation.

10.12.2 Syntax :

Command syntax: AT+CHLD= < n >

Response syntax: +CHLD: (0-4, 11-17, 21-27) for AT+CHLD=?
OK

10.12.3 Defined values

<n>

0: Release all held calls or set User Determined User Busy (UDUB) for a waiting call.

1: Release all active calls (if any exist) and accepts the other (held or waiting) call.

1X: Release a specific call X (active, held or waiting)

2: Place all active calls (if any exist) on hold and accepts the other (held or waiting) call.

2X: Place all active calls on hold except call X with which communication is supported.

3: Adds a held call to the conversation.

4: Connects the two calls and disconnects the subscriber from both calls (Explicit Call Transfer).

10.13 List current calls +CLCC

10.13.1 Description :

This command is used to return a list of current calls.

10.13.2 Syntax :

Command syntax : AT+CLCC

Response syntax: OK if no calls are available

+CLCC : <id1>, <dir>, <stat>, <mode>, <mpty> [,<number>, <type> [<alpha>]] [<CR><LF> +CLCC: <id2>, <dir>, <stat>, <mode>, <mpty> [,<number>, <type> [<alpha>]] [. . .]]

10.13.3 Defined values :

<idx> integer type, call identification as described in GSM 02.30

<dir>

0: mobile originated (MO) call

1: mobile terminated (MT) call

<stat> (state of the call):

<stat>

0: active

1: held

2: dialling (MO call)

3: alerting (MO call)

4: incoming (MT call)

5: waiting (MT call)

<mode> (teleservice) :

<mode>

0 : voice
1: data
2: fax
9: unknown

<mpty>

0: call is not one of multiparty (conference) call parties
1: call is one of multiparty (conference) call parties

<number> string type phone number in format specified by <type>

<type> type of address octet in integer format

<alpha> optional string type alphanumeric representation of <number> corresponding to the entry found in phonebook. *(for UCS2 format see commands examples +CLIP, +CCWA or +COLP)*

10.14 Supplementary service notifications +CSSN

10.14.1 Description :

This command refers to supplementary service related network initiated notifications.

When <n>=1 and a supplementary service notification is received after a mobile originated call setup, intermediate result code **+CSSI:<code1>[,<index>]** is sent before any other MO call setup result codes. When <m>=1 and a supplementary service notification is received during a call, unsolicited result code **+CSSU:<code2>[,<index>[,<number>,<type>]]** is sent.

10.14.2 Syntax :

| | | |
|-------------------------|---------------------|---------------|
| <u>Command syntax:</u> | AT+CSSN= <n>, <m> | |
| <u>Response syntax:</u> | +CSSN: <n>, <m> | for AT+CSSN? |
| | OK | |
| | +CSSN: (0-1), (0-1) | for AT+CSSN=? |
| | OK | |

10.14.3 Defined values

<n> (parameter sets/shows the +CSSI result code presentation status) :

0: disable
1: enable

<m> (parameter sets/shows the +CSSU result code presentation status) :

0 : disable
1 : enable

<code1>

4: closed User Group call, with CUG <index>
5: outgoing calls are barred
6: incoming calls are barred
7: CLIR suppression rejected

<code2>

1: closed User Group call, with CUG <index>

2: call has been put on hold (during a voice call, <number> & <type> fields may be present)

3: call has been retrieved (during a voice call, <number> & <type> fields may be present)

4: multiparty call entered (during a voice call, <number> & <type> fields may be present)

5: call on hold has been released (during a voice call)

7: call is being connected (alerting) with the remote party in alerting state in Explicit Call Transfer operation (during a voice call)

8: call has been connected with the other remote party in Explicit Call Transfer operation (during a voice call, <number> & <type> fields may be present)

<index> Closed User Group index

<number> String type phone number

<type> Type of address

10.15 Unstructured supplementary service data +CUSD

10.15.1 Description :

The USSD supplementary service is described in GSM 02.90.

It is based on sequences of digits which may be entered by a mobile user with a handset. A sequence entered is sent to the network which replies with an alphanumerical string, for display only, or for display plus request for the next sequence.

This command is used to:

- enable or disable the CUSD indication sent to the application by the product when an incoming USSD is received
- send and receive USSD strings

10.15.2 Syntax :

Command syntax : AT+CUSD = <n> [,<str> [<dc>]]

10.15.3 Defined values :

<n>

0 : Disable the result code presentation

1 : Enable the result code presentation

2 : Cancel session (not applicable to read command response)

In case of enabled presentation, a +CUSD (as direct answer to a send USSD) is then indicated with :

+CUSD: <m> [,<str>,<dc>]

<m>

0: no further user action required (network initiated USSD-Notify, or no further information needed after mobile initiated operation)

1: further user action required (network initiated USSD-Request, or further information needed after mobile initiated operation)

2: USSD terminated by network

4: Operation not supported

<str> is network string, converted in the selected character set
<dcS> is the data coding scheme received (GSM TS 03.38).

10.15.4 Syntax To send and receive USSD :

Command syntax: AT+CUSD= <n> [,<str> [,<dcS>]]

Note :

Please, be aware that the send USSD command needs the user to re-enter the <n> parameter !

10.15.5 Defined values To send and receive USSD :

<str> is the USSD string to be sent.

<dcS> the default alphabet and the UCS2 alphabet are supported.

When the product sends a USSD, an OK response is first returned, the intermediate +CUSD indication comes subsequently. In case of error, a +CUSD:4 indication is returned.

10.16 Closed user group +CCUG

10.16.1 Description :

The Closed User Group Supplementary Service enables subscribers to form closed user groups with restricted access (both access to and from). The CUG supplementary service is described in GSM 02.85. This service is provided on prior arrangement with the service provider. Subscription options should be selected at implementation.

The +CCUG command is used to:

- activate/deactivate the control of CUG information for all following outgoing calls,
- select a CUG index,
- suppress outgoing access (OA). OA allows a member of a CUG to place calls outside the CUG.
- suppress the preferential CUG. Preferential is the default CUG used by the network when it does not receive an explicit CUG index.

10.16.2 Syntax :

Command syntax: AT+CCUG = <n> [,<index> [<info>]]

10.16.3 Defined values :

<n>

0 : Disable CUG mode (default)

1 : Enable CUG mode

<index>

0-9: CUG index (0 default),

10: Preferred CUG

<info>

0: No information (default)

1: Suppress OA

2: Suppress preferential CUG

3 : Suppress OA and preferential CUG

To activate the control of the CUG information by call, add [G] or [g] to the ATD command. Index and info values will be used.

11 Data commands

11.1 Using AT Commands during a data connection

To use AT Commands during a data connection (e.g. while the product is in online mode), it is necessary either to switch to offline mode, or to use the **specific +WMUX** command to enable Commands / Data multiplexing.

11.1.1 Switch from online to offline mode

To switch from online mode to offline mode, the “+++” sequence must be sent. Following this, the product gets back to offline mode with an “OK” response, and an AT command can be sent.

Note :

the “+++” sequence only works with the **+ICF** command using the following settings:

- 8 data bits, with no parity
- 7 data bits, with even parity

11.1.2 Switch from offline to online mode

See the **ATO** command description.

11.2 Bearer type selection **+CBST**

11.2.1 Description :

This command applies to both **outgoing** and **incoming data calls**, but in a different way. For an outgoing call, the two parameters (e.g. <speed> and <ce>) apply, whereas for an incoming call, only the <ce> parameter applies.

Note 1) For incoming calls, if <ce> is set to T only and the network offers NT only or vice versa, then the call is released.

Note 2) The former values of 100 and 101 for <ce> are retained for compatibility purposes but should no longer be used, values 2 and 3 should be used instead.

11.2.2 Syntax :

Command syntax: AT+CBST= <speed>, <name>, <ce>

| Command | Possible responses |
|--|--|
| AT+CBST=? <i>Note : Test command</i> | +CBST: (0-8,65,66,68,70,71),(0),(0-3) OK <i>Note : Data 14,4 kbps not supported</i> |
| AT+CBST=? <i>Note : Test command</i> | +CBST: (0-8,12,14,65,66,68,70,71,75),(0),(0-3) OK <i>Note : Data 14,4 kbps not supported</i> |
| AT+CBST=7,0,1 <i>Note : Ask for a bearer</i> | OK <i>Note : Bearer supported</i> |
| AT+CBST? <i>Note : Current values</i> | +CBST:7,0,1 OK <i>Note : Command valid</i> |
| AT+CBST=81,0,0 <i>Note : Ask for a bearer</i> | +CME ERROR : 4 <i>Note : Bearer not supported</i> |

11.2.3 Defined values :

No data compression is provided and only asynchronous modem is supported (<name> = 0).

<speed>

| | |
|--------------|---------------------------------|
| 0 (default): | Autobauding (modem type : none) |
| 1: | 300 bps (modem type: V.21) |
| 2: | 1200 bps (modem type: V.22) |
| 3: | 1200/75 bps (modem type: V.23) |
| 4: | 2400 bps (modem type: V.22bis) |
| 5: | 2400 bps (modem type: V.26ter) |
| 6: | 4800 bps (modem type: V.32) |
| 7: | 9600 bps (modem type: V.32) |
| 8: | Specific |
| 12: | 9600 bps (modem type: V.34) |
| 14(*): | 1400 bps (modem type : V.34) |
| 65: | 300 bps (modem type: V.110) |
| 66: | 1200 bps (modem type: V.110) |
| 68: | 2400 bps (modem type: V.110) |
| 70: | 4800 bps (modem type: V.110) |
| 71: | 9600 bps (modem type: V.110) |
| 75(*): | 14400 bps (modem type: V.110) |

(*)This speed configures data and fax 14.4 kbps bearers.

<ce> : Connection element

<ce>

| | |
|--------------|---------------------------|
| 0: | Transparent only |
| 1(default) : | Non transparent only |
| 2: | Transparent preferred |
| 3: | Non transparent preferred |

11.3 Select mode +FCLASS

11.3.1 Description

This command puts the product into a particular operating mode (data or fax).

11.3.2 Syntax :

Command syntax: AT+FCLASS= <n>

| Command | Possible responses |
|---|---|
| AT+FCLASS=? <i>Note : Test command</i> | +FCLASS: (0,1) OK <i>Note : Fax class 2 not supported</i> |
| AT+FCLASS=? <i>Note : Test command</i> | +FCLASS: (0,1,2) OK <i>Note : Fax class 2 supported</i> |
| AT+FCLASS=0 <i>Note : Data mode requested</i> | OK <i>Note : Command valid</i> |
| AT+FCLASS=1 <i>Note : Fax class 1 mode requested</i> | OK <i>Note : Command valid</i> |
| AT+FCLASS? <i>Note : Current value</i> | +FCLASS: 1 OK <i>Note : Command valid</i> |

11.3.3 Defined values :

<n>

0: Data

1: Fax class 1

2: Fax class 2

11.4 Service reporting control +CR

11.4.1 Description :

This command enables a more detailed type of service reporting in the case of **incoming or outgoing data calls**. Before sending the CONNECT response to the application, the product will specify the type of data connection that has been set up.

These report types are :

| | |
|----------------|----------------------------------|
| +CR: ASYNC | For asynchronous transparent |
| +CR: REL ASYNC | For asynchronous non-transparent |

11.4.2 Syntax :

Command syntax : AT+CR

| Command | Possible responses |
|--|-----------------------------------|
| AT+CR=0 <i>Note : Extended reports disabled</i> | OK <i>Note : Command valid</i> |
| AT+CR=1 <i>Note : Extended reports enabled</i> | OK <i>Note : Command valid</i> |

11.5 Cellular result codes +CRC

11.5.1 Description :

This command gives more detailed ring information for an **incoming call** (voice or data). Instead of the string "RING", an extended string is used to indicate which type of call is ringing (e.g. +CRING: VOICE).

These extended indications are:

| | |
|-------------------|----------------------------------|
| +CRING: ASYNC | for asynchronous transparent |
| +CRING: REL ASYNC | for asynchronous non-transparent |
| +CRING: VOICE | for normal speech. |
| +CRING : FAX | for fax calls |

11.5.2 Syntax :

Command syntax : AT+CRC

| Command | Possible responses |
|---|-----------------------------------|
| AT+CRC=0 <i>Note : Extended reports disabled</i> | OK <i>Note : Command valid</i> |
| AT+CRC=1 <i>Note : Extended reports enabled</i> | OK <i>Note : Command valid</i> |

11.6 DTE-DCE local rate reporting +ILRR

11.6.1 Description :

This parameter controls whether or not the extended-format "+ILRR:<rate>" information text is transmitted from the DCE to the DTE. The <rate> reported represents the current (negotiated or renegotiated) DTE-DCE rate.

If enabled, the intermediate result code is transmitted in an **incoming or outgoing data call**, after any data compression report, and before any final result code (CONNECT).

<rate> can take the following values: 300, 600, 1200, 2400, 4800, 9600, 19200, 38400, 57600, 115200.

11.6.2 Syntax :

Command syntax : AT+ILRR

 confidential ©

| Command | Possible responses |
|--|-----------------------------------|
| AT+ILRR=0 <i>Note : Local port rate report disabled</i> | OK <i>Note : Command valid</i> |
| AT+ILRR=1 <i>Note : Local port rate report enabled</i> | OK <i>Note : Command valid</i> |

11.7 Radio link protocol parameters +CRLP

11.7.1 Description :

This command allows the radio link protocol parameters used for **non transparent data transmission** to be changed.

11.7.2 Syntax :

Command syntax: AT+CRLP=<iws>,<mws>,<T1>,<N2>, <ver>

| Command | Possible responses |
|--|---|
| AT+CRLP=? <i>Note : Test command</i> | +CRLP: (0-61),(0-61),(40-255),(1,255),(0) OK <i>Note : V42bis not supported</i> |
| AT+CRLP=? <i>Note : Test command</i> | +CRLP: (0-61),(0-61),(40-255),(1,255),(0,1) OK <i>Note : V42bis supported</i> |
| AT+CRLP=61,61,48,6,0 <i>Note : Set new parameters</i> | OK <i>Note : Command valid</i> |
| AT+CRLP? <i>Note : Current values</i> | AT+CRLP: 61,61,48,6,0 <i>Note : Command valid</i> |

11.7.3 Defined values :

This command accepts 5 parameters.

- <iws> 0-61: Down window size, (default is 61),
- <mws> 0-61: Up window size, (default is 61),
- <T1> 40-255 : Acknowledgement timer in units of 10ms, (default is 48)
- <N2> 1-255: Retransmission attempts, (default is 6),
- <ver> 0-1: Version number.
If V42bis is supported the version is 1.
If V42bis is not supported the version is 0

11.8 Others radio link parameters +DOPT

11.8.1 Description :

This Wavecom specific command allows some supplementary radio link protocol parameters to be changed.

11.8.2 Syntax :

Command syntax: AT+DOPT=<reset_allowed>,<dtx_allowed>

| Command | Possible responses |
|---|---|
| AT+DOPT=1 <i>Note : Set new parameters</i> | OK <i>Note : Command valid</i> |
| AT+DOPT=? <i>Note : Test command</i> | (0,1),(0,1) OK <i>Note : DTX is supported</i> |
| AT+DOPT=1,1 <i>Note : Set new parameters</i> | OK <i>Note : Command valid</i> |
| AT+DOPT? <i>Note : Current values</i> | 1,1 OK <i>Note : Command valid</i> |

11.8.3 Defined values :

<reset_allowed>

0: Data communication is hung up in case of bad radio link.

1 (default): Data communication continues in case of bad radio link
(possible loss of data)

< dtx_allowed >

0: Normal mode

1 (default): Economic battery mode (not supported by all networks)

11.9 Select data compression %C

11.9.1 Description :

This command enables or disables data compression negotiation if this feature is supported on the product.

11.9.2 Syntax :

Command syntax : AT%C<n>

| Command | Possible responses |
|--------------------------------------|--|
| AT%C0 <i>Note : Command</i> | OK <i>Note : Feature supported</i> |
| AT%C2 <i>Note : Command</i> | OK <i>Note : V42bis supported</i> |
| AT%C? <i>Note : Current value</i> | 2 OK <i>Note : Command valid</i> |

11.9.3 Defined values :

<n>

0(default): no compression

2: V42bis compression if supported

11.10 V42 bis data compression +DS

11.10.1 Description :

This command enables or disables V.42bis data compression if this feature is supported on the product.

11.10.2 Syntax :

Command syntax : AT+DS=<dir>,<neg>,<P1>,<P2>

| Command | Possible responses |
|--|--|
| AT+DS=? <i>Note : Test command</i> | +DS: (0-3),(0,1),(512-4096),(6-250) OK <i>Note :</i> |
| AT+DS=3,0,4096,250 <i>Note : Set new parameters</i> | OK <i>Note : Command valid</i> |
| AT+DS? <i>Note : Current values</i> | +DS: 3,0,4096,20 OK <i>Note : Command valid</i> |

11.10.3 Defined values :

Four numeric sub-parameters are accepted:

<dir>: specifies the desired direction(s) of operation of the data compression function; from the DTE point of view, **(default is 3)**,

<dir>

0: Negotiated ... no compression

1: Transmit only

2: Receive only

3: Both directions, accept any direction

<neg>: specifies whether or not the DCE should continue to operate if the desired result is not obtained, **(default is 0)**,

< neg >

- 0: Do not disconnect if V.42 bis is not negotiated by the remote DCE as specified in <dir>
- 1: Disconnect if V.42 bis is not negotiated by the remote DCE as specified in <dir>

< P1 >

512-4096: specifies the maximum number of dictionary entries that should be negotiated, **(default is 4096),**

< P2 >

6-250: specifies the maximum string length to be negotiated, **(default is 250).**

11.11 V42 bis data compression report +DR

11.11.1 Description :

If this feature is provided by the product this command determines whether or not the use of V42bis is given in an **incoming or outgoing data call**.

The intermediate result code represents current DCE-DCE data compression type. The format of this result code is as follows:

| | |
|--------------|--|
| +DR: NONE | Data compression is not in use |
| +DR: V42B | Rec. V.42 bis is in use in both directions |
| +DR: V42B RD | Rec. V.42 bis is in use in receive direction only |
| +DR: V42B TD | Rec. V.42 bis is in use in transmit direction only |

The +DR intermediate result code, if enabled, is issued before the final result code, before the +ILRR intermediate report and after the service report control +CR.

11.11.2 Syntax :

Command syntax : AT+DR

| Command | Possible responses |
|--|---|
| AT+DR=? <i>Note : Test command</i> | +DR: (0,1) OK <i>Note :</i> |
| AT+DR=1 <i>Note : Reporting enabled</i> | OK <i>Note : Command valid</i> |
| AT+DR? <i>Note : Current value</i> | +DR: 1 OK <i>Note : Command valid</i> |

11.12 Select data error correcting mode \N

11.12.1 Description :

If this feature is provided by the product, this command controls the preferred error correcting mode for a data connection. It can only be used for **transparent data transmission**.

If the V42 feature is provided, the product authorizes LAPM error correction mode.

If the MNP2 feature is provided, the product authorizes MNP error correction mode.

11.12.2 Syntax :

Command syntax : AT\N<n>

| Command | Possible responses |
|--|--|
| AT\N0 <i>Note : no error correction</i> | OK |
| AT\N? <i>Note : Current value</i> | 0 OK <i>Note : Command valid</i> |
| AT\N4 <i>Note : LAPM error correction selection</i> | +CME ERROR: 3 <i>Note : V42 feature is not provided</i> |

11.12.3 Defined values :

<n>

0(default): Disables error correction mode

2: Selects an auto reliable mode (LAPM connection, then MNP connection)

4: Selects LAPM error correction mode

5: Selects MNP error correction mode

Note:

+E prefixed commands of V.25 ter are not used.

12 Fax commands

The fax service provided by the product is class 1 compatible. However, only the core commands defined by ITU T.31 are supported. This means that commands such as AT+FAR, +FCC, etc. are not supported. Autobauding must be enabled to set up the product for fax.

All set commands below return an **ERROR** response code if they are not issued during communication.

12.1 Transmit speed +FTM

12.1.1 Description :

This command sets the fax transmit speed.

12.1.2 Syntax :

Command syntax: AT+FTM=<speed>

| Command | Possible responses |
|--|--|
| AT+FTM=? <i>Note : Test command</i> | (24,48,72,73,74,96,97,98,121,122,145,146) OK <i>Note : Fax 14.4 kbps supported</i> |

12.1.3 Defined values :

<speed>

| | |
|------|--------------------------------------|
| 24: | 2400 bps (modem type: V.27ter) |
| 48: | 4800 bps (modem type: V.27ter) |
| 72: | 7200 bps (modem type: V.29) |
| 73: | 7200 bps (long) (modem type: V.17) |
| 74: | 7200 bps (short) (modem type: V.17) |
| 96: | 9600 bps (modem type: V.29) |
| 97: | 9600 bps (long) (modem type: V.17) |
| 98: | 9600 bps (short) (modem type: V.17) |
| 121: | 12000 bps (long) (modem type: V.17) |
| 122: | 12000 bps (short) (modem type: V.17) |
| 145: | 14400 bps (long) (modem type: V.17) |
| 146: | 14400 bps (short) (modem type: V.17) |

12.2 Receive speed +FRM

12.2.1 Description :

This command sets the fax receive speed.

12.2.2 Syntax :

Command syntax: AT+FRM=<speed>

| Command | Possible responses |
|--|--|
| AT+FRM=? <i>Note : Test command</i> | (24,48,72,73,74,96,97,98,121,122,145,146) OK <i>Note : Fax 14.4 kbps supported</i> |

12.2.3 Defined values :

The speed values are identical to those of the +FTM command (see 12.1.3 Defined values).

12.3 HDLC transmit speed +FTH

12.3.1 Description :

This command sets the fax transmit speed, using the HDLC protocol.

12.3.2 Syntax :

Command syntax: AT+FTH=<speed>

| Command | Possible responses |
|--|----------------------------|
| AT+FTH=? <i>Note : Test command</i> | (3) OK <i>Note :</i> |

12.3.3 Defined values :

<speed> can only take the value 3, which corresponds to V.21 channels 300 bps.

12.4 HDLC receive speed +FRH

12.4.1 Description :

This command sets the fax receive speed, using the HDLC protocol.

12.4.2 Syntax :

Command syntax: AT+FRH=<speed>

| Command | Possible responses |
|--|----------------------------|
| AT+FRH=? <i>Note : Test command</i> | (3) OK <i>Note :</i> |

12.4.3 Defined values :

<speed> can only take the value 3, which corresponds to V.21 channels 300 bps.

12.5 Stop transmission and wait +FTS**12.5.1 Description :**

This command stops transmission for the period specified.

12.5.2 Syntax :

Command syntax: AT+FTS=<n>

| Command | Possible responses |
|--|-----------------------------------|
| AT+FTS=? <i>Note : Test command</i> | (0-255) OK <i>Note :</i> |
| AT+FTS=50 <i>Note : Stops transmission and waits for 0.5s</i> | OK <i>Note : Command valid</i> |

12.5.3 Defined values :

<n> : silence period (units of 10 ms).

12.6 Receive silence +FRS**12.6.1 Description :**

This command causes the modem to stop listening to the network and report back to the DTE after the specified period.

It is aborted if any character is received from the application.

12.6.2 Syntax :

Command syntax: AT+FRS=<n>

| Command | Possible responses |
|--|-----------------------------------|
| AT+FRS=? <i>Note : Test command</i> | (0-255) OK <i>Note :</i> |
| AT+FRS=50 <i>Note : Stops transmission and waits for 0.5s</i> | OK <i>Note : Command valid</i> |

12.6.3 Defined values :

<n> is in units of 10 ms.

12.7 Setting up the PC fax application:

The recommended fax application is *Delrina WinFax v8.0*.

It should be configured as follows (menu Setup/Fax Modem Setup):

- Port: any com
- Model: Generic Class 1 (hardware flow control). A generic class 1 with software flow control can also be selected.
- Init: default string is suitable for the product
- Reset: default string is suitable for the product
- Maximum Transmit Rate: 9600 baud (if higher rate will be automatically cut back to 9600 baud).

Other settings are of no relevance for the GSM unit: they can be modified.

13 Fax class 2 commands

If the feature is supported, the commands +FDT, +FDR, +FET, +FPTS and +FK must be used during communication only.

The other commands, +FBOR, +FBUF, +FCQ, +FCR, +FDCC, +FDIS, +FLID and +FPHCTO, cannot be used during communication.

13.1 Transmit Data +FDT

13.1.1 Description :

This command prefixes data transmission.

13.1.2 Syntax :

Command syntax: AT+FDT

13.2 Receive Data +FDR

13.2.1 Description :

This command initiates data reception.

13.2.2 Syntax :

Command syntax : AT+FDR

13.3 Transmit page punctuation +FET

13.3.1 Description :

This command punctuates page and document transmission after +FDT commands. It indicates that the current page is complete, and whether or not there are additional pages to be sent.

13.3.2 Syntax :

Command syntax: AT+FET=<ppm>

13.3.3 Defined values :

<ppm>

0: Another page next, same document

1: Another document next

2: No more pages or documents

3: Another partial page next
4: Another page, procedure interrupt
5: Another document, procedure interrupt
6: All done, procedure interrupt
The remote station should respond with +FPTS:<ppr>

13.4 Page transfer status parameters +FPTS

13.4.1 Description :

This command sets post page transfer response.

13.4.2 Syntax :

Command syntax: AT+FPTS=<ppr>

13.4.3 Defined values :

<ppm>

- 1: Page good
- 2: Page bad ; retrain requested
- 3: page good ; retrain requested
- 4: Page bad ; interrupt requested
- 5: Page good ; interrupt requested

13.5 Terminate Session +FK

13.5.1 Description :

This command causes the product to terminate the session.

13.5.2 Syntax :

Command syntax: AT+FK

13.6 Page transfer bit order +FBOR

13.6.1 Description :

This command sets the bit order for negotiation and fax page transfer. The order is related to the bit order or radio link.

13.6.2 Syntax :

Command syntax: AT+FBOR=<n>

| Command | Possible responses |
|---|------------------------------|
| AT+FBOR=? <i>Note : Test command</i> | (0-3) OK <i>Note :</i> |

13.6.3 Defined values :

| <n> | Bit order for negotiation | Bit order for page transfer |
|------------|---------------------------|-----------------------------|
| 0(default) | Same | Same |
| 1 | Same | Reverse |
| 2 | Reverse | Same |
| 3 | Reverse | Reverse |

13.7 Buffer size report +FBUF

13.7.1 Description :

This command requests the size of the exchange buffer between the modem and the fax application.
Only the read command is supported.

13.7.2 Syntax :

Command syntax : AT+FBUF

| Command | Possible responses |
|---|---|
| AT+FBUF? <i>Note : Current value</i> | 1024 OK <i>Note : Command valid</i> |

13.8 Copy quality checking +FCQ

13.8.1 Description :

This command controls Copy Quality checking for receiving faxes.

13.8.2 Syntax :

Command syntax : AT+FCQ=<n>

| Command | Possible responses |
|--|----------------------------|
| AT+FCQ=? <i>Note : Test command</i> | (0) OK <i>Note :</i> |

13.9 Capability to receive +FCR

13.9.1 Description :

This commands controls the capability of the modem to accept incoming faxes.

13.9.2 Syntax :

Command syntax: AT+FCR=<n>

| Command | Possible responses |
|--|------------------------------|
| AT+FCR=? <i>Note : Test command</i> | (0,1) OK <i>Note :</i> |

13.9.3 Defined values :

<n>

0: The modem will not accept incoming faxes.

1(default): The modem will accept incoming faxes.

13.10 Current sessions parameters +FDIS

13.10.1 Description :

This command allows the DTE to parameter the capabilities used for the current session.

13.10.2 Syntax :

Command syntax: AT+FDIS=<vr>,
,<wd>,<ln>,<df>,<ec>,<bf>,<st>

| Command | Possible responses |
|----------------------------|--|
| AT+FDIS=? <i>Note :</i> | (0,1),(0-5),(0-2),(0-2),(0-3),(0),(0),(0-7) OK <i>Note : Fax ECM not supported Fax 14,4 kbps supported</i> |
| | (0,1),(0-3),(0-2),(0-2),(0-3),(0),(0),(0-7) OK <i>Note : Fax ECM not supported Fax 14,4 kbps not supported</i> |

13.10.3 Defined values :

This command accepts eight numeric parameters (of the T30 standard):

<vr>: Vertical Resolution,

< vr >

0(default): Normal: 98 lpi

1: Fine: 196 lpi

: Bit Rate,

< br >

0: 2400 bps (modem type: V.27 ter)

1: 4800 bps (modem type: V.27 ter)

2: 7200 bps (modem type: V.29)

3: 9600 bps (modem type: V.29, V.17)

4(*): 12000 bps (modem type: V.33, V.17)

5(*): 14400 bps (modem type: V.33, V.17)

(*) Only when product supports 14,4 kbps data feature

If this feature is supported, default is 5, otherwise default is 3.

<wd>: Page Width,

< wd >

0(default): 1728 pixels in 215 mm

1: 2048 pixels in 255 mm

2: 2432 pixels in 303 mm

<ln>: Page Length,

< in >

0: A4, 297 mm

1: B4, 364 mm

2(default) : Unlimited

<df> : Data Compression Format,

< df >

0(default): 1-D modified huffman

1: 2-D modified read

2: 2-D uncompressed mode

3: 2-D modified modified read

<ec> : Error Correction,

< ec >

0: Disable Fax ECM

1(*): Enable Fax ECM, 64 bytes/frame

2(*): Enable Fax ECM, 256 bytes/frame

(*) Only when product supports fax Error Correction Mode feature

If this feature is supported, default is 2, else default is 0.

<bf> : Binary File Transfer,

Only <bf> set to 0 is supported.

<st> : Scan Time per line,

| <st> | Description <vr>=0 | Description <vr>=1 |
|------------|--------------------|--------------------|
| 0(default) | 0 ms | 0 ms |
| 1 | 5 ms | 5 ms |
| 2 | 10 ms | 5 ms |
| 3 | 10 ms | 10 ms |
| 4 | 20 ms | 10 ms |
| 5 | 20 ms | 20 ms |
| 6 | 40 ms | 20 ms |
| 7 | 40 ms | 40 ms |

13.11 DCE capabilities parameters +FDCC

13.11.1 Description :

This command allows the DTE to parameter the capabilities used for any session.

13.11.2 Syntax :

Command syntax: AT+FDCC=<vr>,
,<wd>,<ln>,<df>,<ec>,<bf>,<st>

| Command | Possible responses |
|--|--|
| AT+ FDCC=? <i>Note : Test command</i> | (0,1),(0-5),(0-2),(0-2),(0-3),(0-2),(0),(0-7) OK <i>Note : Fax ECM supported Fax 14,4 kbps supported</i> |
| | (0,1),(0-5),(0-2),(0-2),(0-3),(0),(0),(0-7) OK <i>Note : Fax ECM not supported Fax 14,4 kbps supported</i> |
| | (0,1),(0-3),(0-2),(0-2),(0-3),(0-2),(0),(0-7) OK <i>Note : Fax ECM supported Fax 14,4 kbps not supported</i> |
| | (0,1),(0-3),(0-2),(0-2),(0-3),(0),(0),(0-7) OK <i>Note : Fax ECM not supported Fax 14,4 kbps not supported</i> |

13.11.3 Defined values :

The parameters and default values are the same as for the +FDIS command (see 13.10.3 Defined values).

13.12 Local ID string +FLID

13.12.1 Description :

This command allows the local ID string to be defined.

13.12.2 Syntax :

Command syntax: AT+FLID="<string>"

The string has a limited size, and accepts any characters between 32 and 127.

| Command | Possible responses |
|---|---------------------|
| AT+FLID=? <i>Note : Test command</i> | (20),(32-127) OK |

13.13 Page transfer timeout parameter +FPHCTO

13.13.1 Description :

This command sets the period the modem waits for another page before it assumes there are no more pages and aborts.

13.13.2 Syntax :

Command syntax: AT+FPHCTO=<n> (default is 30)

| Command | Possible responses |
|---|--------------------|
| AT+FPHCTO=? <i>Note : Test command</i> | (0-255) OK |

13.14 Fax Class 2 indication messages

The following messages are used to indicate DCE Responses. They are used in communication only.

+FCON:

This response indicates connection with a fax machine.

**+FDCS <vr>,
,<wd>,<ln>,<df>,<ec>,<bf>,<st>:**

This response reports current session capabilities. The parameters are the same than those of AT+FDIS command (*see 13.10*).

**+FDIS <vr>,
,<wd>,<ln>,<df>,<ec>,<bf>,<st>:**

This response reports remote capabilities. The parameters are the same than those of AT+FDIS command (*see 13.10*).

+FCFR:

This response indicates confirmation to receive.

+FTSI "<string>":

This response reports the received transmit station ID string.

+FCSI "<string>":

This response reports the received called station ID string.

+FPTS <ppr>:

This response reports received page transfer status. The parameter is the same than the one of AT+FPTS command (*see 13.4*).

+FET <ppm>:

This response reports post page message response. The parameter is the same than the one of AT+FET command (*see 13.3*).

+FHNG <cause>:

This response reports the hang-up cause. It indicates that the call has been terminated.

<cause>

- 0:** Normal end of connection.
- 10:** Unspecified transmit phase A error.
- 20:** Unspecified transmit phase B error.
- 40:** Unspecified transmit phase C error.
- 50:** Unspecified transmit phase D error.
- 70:** Unspecified receive phase B error.
- 90:** Unspecified receive phase C error.
- 100:** Unspecified receive phase D error.

14 V24-V25 commands

14.1 Fixed DTE rate +IPR

14.1.1 Description :

This commands specifies the data rate at which the DCE will accept commands.

14.1.2 Syntax :

Command syntax : AT+IPR

| Command | Possible responses |
|-------------------------------|--|
| AT+IPR? <i>Note :</i> | +IPR: 9600 OK <i>Note : Current rate is 9600 bps</i> |
| AT+IPR=? <i>Note :</i> | +IPR: (0,2400,4800,9600,19200), (300,600,1200,38400,57600,115200) OK <i>Note : Possible value (*)</i> |
| AT+IPR=38400 <i>Note :</i> | OK <i>Note : Disable autobauding and set rate to 38400 bps</i> |
| AT+IPR=0 <i>Note :</i> | OK <i>Note : Enable autobauding</i> |

(*) the first set of values indicates the range of auto-detectable speeds.

The second set of values indicates all possible speeds that can be used by the DCE.

Autobauding is supported (operating from 1200 to 38400 baud). However some constraints have to be taken into account:

any AT command issued by the DTE must start with both capital 'A' and 'T' (or '/') or both lower case 'a' and 't' (or '/') ; otherwise the DCE may return some garbage characters and become de-synchronized. Should this happen, the DTE simply issues 'AT\r' (at 2400 or 4800 bauds) once or twice or just 'AT' (at 9600 bauds) to re-synchronize the modem.

the DTE waits for 1ms after receiving the last character of the AT response (which is always '\n' or 0x0A) to send a new AT command at either the same rate or a new rate. Should this delay be ignored, the DCE can become de-synchronised. Once again, sending 'AT\r' once or twice or just 'AT' causes the DCE to recover.

Caution:

when starting up, if autobauding is enabled and no AT command has yet been received, the product sends all unsolicited responses (like RING) at 9600 bauds.

14.2 DTE-DCE character framing +ICF

14.2.1 Description :

This command is used to determine the local serial port start-stop (asynchronous) character framing that the DCE uses.

14.2.2 Syntax :

Command syntax: AT+ICF= <format>[, <parity>]

| Command | Possible responses |
|-------------------------------|---|
| AT+ICF? <i>Note :</i> | +ICF: 3,4 OK <i>Note : Current values</i> |
| AT+ICF=? <i>Note :</i> | +ICF: (1-6),(0-4) OK <i>Note : Possible values</i> |
| AT+IPR=38400 <i>Note :</i> | OK <i>Note : Disable autobauding and set rate to 38400 bps</i> |
| AT+ICF=2,0 <i>Note :</i> | OK <i>Note : New values</i> |

14.2.3 Defined values :

<format>

| | | |
|----|------------------------|-----------------|
| 0: | Autodetect | (not supported) |
| 1: | 8 Data 2 Stop | (supported) |
| 2: | 8 Data 1 Parity 1 Stop | (supported) |
| 3: | 8 Data 1 Stop | (supported) |
| 4: | 7 Data 2 Stop | (supported) |
| 5: | 7 Data 1 Parity 1 Stop | (supported) |
| 6: | 7 Data 1 Stop | (supported) |

<parity>

| | | |
|----|-------|-------------|
| 0: | Odd | (supported) |
| 1: | Even | (supported) |
| 2: | Mark | (supported) |
| 3: | Space | (supported) |
| 4: | None | (supported) |

If <format> is equal to 1,3,4 or 6, <parity> field is ignored. If <format> is equal to 2 or 5, and <parity> is not given in the command, default value 3 (space) will be used.

Note 1) setting a character framing different from 8N1 will disable autobauding (in the case it was activated). However setting it back to 8N1 will not re-enable autobaud.

Note 2) setting the framing to 8N1 will let the autobauding enabled, if it was already enabled (implying framing was already 8N1).

14.3 DTE-DCE local flow control +IFC

14.3.1 Description :

This command is used to control the operation of local flow control between the DTE and DCE.

14.3.2 Syntax :

Command syntax : AT+IFC=<DCE_by_DTE>,<DTE_by_DCE>

| Command | Possible responses |
|-----------------------------|--|
| AT+IFC? <i>Note :</i> | +IFC: 2,2 OK <i>Note : Current values</i> |
| AT+IFC=? <i>Note :</i> | +IFC: (0,2),(0,2) OK <i>Note : Possible values</i> |
| AT+IFC=0,0 <i>Note :</i> | OK <i>Note : New values</i> |

14.3.3 Defined values :

< DCE_by_DTE >

- 0: none (supported)
- 1: Xon/Xoff local circuit 103 (not supported)
- 2: RTS (supported)
- 3: Xon/Xoff global on circuit 103 (not supported)

Important note:

when this parameter is set to 2 (DTE invokes flow control through RTS) DCE behaviour is as follows:

If the DCE has never detected RTS in the high (or ON) condition since startup then it ignores RTS as it assumes that this signal is not connected.

As soon as the DCE detects RTS high the signal acts on it. Therefore subsequent RTS transition to OFF will prevent the DCE from sending any further data in both online and offline modes.

This behaviour allows the user to use the default settings (hardware flow control) and leave RTS disconnected. In the case where RTS is connected and is high at least once, it acts on the DCE.

< DTE_by_DCE >

- 0: none (supported)
- 1: Xon/Xoff circuit 104 (not supported)
- 2: CTS (supported)

When this parameter is set to 0 (none) then CTS is kept high all the time.

14.4 Set DCD signal &C

14.4.1 Description :

This commands controls the Data Carrier Detect (DCD) signal.

14.4.2 Syntax :

Command syntax : AT&C

| Command | Possible responses |
|---|-----------------------------------|
| AT&C0 <i>Note : DCD always on</i> | OK <i>Note : Command valid</i> |
| AT&C1 <i>Note : DCD matches state of the remote modem's data carrier</i> | OK <i>Note : Command valid</i> |

14.5 Set DTR signal &D

14.5.1 Description :

This commands controls the Data Terminal Ready (DTR) signal.

14.5.2 Syntax :

Command syntax : AT&D

| Command | Possible responses |
|--|-----------------------------------|
| AT&D0 <i>Note : The DTR signal is ignored</i> | OK <i>Note : Command valid</i> |
| AT&D1 <i>Note : Modem switches from data to command mode when DTR switches from ON to OFF</i> | OK <i>Note : Command valid</i> |
| AT&D2 <i>Note : Upon DTR switch from ON to OFF, the call is released</i> | OK <i>Note : Command valid</i> |

14.6 Set DSR signal &S

14.6.1 Description :

This commands controls the Data Set Ready (DSR) signal.

14.6.2 Syntax :

Command syntax : AT&S

| Command | Possible responses |
|---|-----------------------------------|
| AT&S0 <i>Note : DSR always on</i> | OK <i>Note : Command valid</i> |
| AT&S1 <i>Note : DSR off in command mode, DSR on in data mode</i> | OK <i>Note : Command valid</i> |

14.7 Back to online mode O

14.7.1 Description

If a connection has been established and the ME is in command mode, this command allows you to return to online data mode.

14.7.2 Syntax

Command syntax : ATO

| Command | Possible responses |
|--|--------------------|
| ATO Return from offline mode to online mode | OK |

14.8 Result code suppression Q

14.8.1 Description :

This command determines whether the mobile equipment sends result codes or not

14.8.2 Syntax :

Command syntax : ATQ

| Command | Possible responses |
|---|-------------------------------------|
| ATQ0 <i>Note : DCE transmits result codes</i> | OK <i>Note : Command valid</i> |
| ATQ1 <i>Note : Result codes are suppressed and not transmitted</i> | (none) <i>Note : No response</i> |

14.9 DCE response format V

14.9.1 Description :

This command determines the DCE response format, with or without header characters <CR><LF>, and with the use of numeric result codes.

| | V0 | V1 |
|-----------------------|--------------------|------------------------------------|
| Information responses | <text><CR><LF> | <CR><LF> <text><CR><LF> |
| Result codes | <numeric code><CR> | <CR><LF> <verbose code><CR><LF> |

14.9.2 Syntax :

Command syntax : ATV

| Command | Possible responses |
|---|--|
| ATV0 <i>Note : DCE transmits limited headers and trailers and numeric result codes</i> | 0 <i>Note : Command is valid (0 means OK)</i> |
| ATV1 <i>Note : DCE transmits full headers and trailers and verbose response text</i> | OK <i>Note : Command valid</i> |

14.10 Default configuration Z

14.10.1 Description :

This command restores the configuration profile. Any call is released.

14.10.2 Syntax :

Command syntax : ATZ

| Command | Possible responses |
|----------------------|-----------------------------------|
| ATZ <i>Note :</i> | Ok <i>Note : Command valid</i> |

14.11 Save configuration &W

14.11.1 Description :

This commands writes the active configuration to a non-volatile memory (EEPROM). Description of the stored parameters is given in paragraph 18.10

14.11.2 Syntax :

Command syntax : AT&W

| Command | Possible responses |
|--|-----------------------------------|
| AT&W <i>Note : Writes current configuration to EEPROM</i> | OK <i>Note : Command valid</i> |

14.12 Auto-tests &T

14.12.1 Description :

AT&T0 is used to perform auto-tests. The response will be OK if no software problem is detected (EEPROM, RAM and ROM checksums), otherwise a simple ERROR response is sent.

AT&T1 is used to close the audio loop and **AT&T2** is used to open the audio loop. This is used to validate the audio loop (microphone to speaker).

14.12.2 Syntax :

Command syntax : AT&T

| Command | Possible responses |
|--|---|
| AT&T0 <i>Note : Perform software auto-tests</i> | OK <i>Note : No software problem detected, all checksums are correct</i> |
| AT&T1 <i>Note : Do the audio loop test (close)</i> | OK <i>Note : Command valid</i> |
| AT&T2 <i>Note : Stop the audio loop test (open)</i> | OK <i>Note : Command valid</i> |

14.13 Echo E

14.13.1 Description :

This command is used to determine whether or not the modem echoes characters received by an external application (DTE).

14.13.2 Syntax :

Command syntax : ATE

| Command | Possible responses |
|---|--------------------------|
| ATE0 <i>Note : Characters are not echoed</i> | OK <i>Note : Done</i> |
| ATE1 <i>Note : Characters are echoed</i> | OK <i>Note : Done</i> |

14.14 Restore factory settings &F

14.14.1 Description :

This command is used to restore the factory settings from EEPROM.

It only restores the parameters that can be found in table 19.10 with AT&F column checked. Those parameters are restored in RAM and in E2P, overwriting the profile seted with AT&W.

14.14.2 Syntax :

Command syntax : AT&F

| Command | Possible responses |
|---|--------------------------|
| AT&F <i>Note : Ask for restoring the factory settings</i> | OK <i>Note : Done</i> |
| AT&F0 <i>Note : Ask for restoring the factory settings</i> | OK <i>Note : Done</i> |

14.15 Display configuration &V

14.15.1 Description

This command is used to display the modem configuration.

&V

&V0 : Display the modem configuration in RAM.

&V1 : Display the modem configuration in EEPROM.

&V2 : Display the modem factory configuration.

The parameters displayed are the following :

Q, V, S0, S2, S3, S4, S5,
+CR, +CRC, +CMEE, +CBST,
+SPEAKER, +ECHO, &C, &D, %C
+IPR, +ICF, +IFC

14.15.2 Syntax :

Command syntax : AT&V

| Command | Possible responses |
|--|--|
| AT&V <i>Note : Display active parameters in RAM</i> | Q:0 V:1 S0:000 S2:043 S3:013 S4:010 S5:008 +CR:0 +CRC:0 +CMEE:0 +CBST:0,0,1 +SPEAKER:0 +ECHO:0,0 &C:1 &D:2 %C:0 +IPR:9600 +ICF:3,4 +IFC:2,2 OK <i>Note : Done</i> <i>For Echo the first value corresponds to Echo cancellation 1.</i> |

14.16 Request identification information I

14.16.1 Description :

This command causes the product to transmit one or more lines of specific information text.

I0 : Display manufacturer followed by model identification. This command is equivalent to +CGMI and +CGMM.

- I3** : Display revision identification (equivalent to +CGMR).
I4 : Display modem configuration in RAM (equivalent to &V0).
I5 : Display modem configuration in EEPROM (equivalent to &V1).
I6 : Display modem data features. This command lists the supported data rates, data modes, and fax classes.
I7 : Display modem voice features.
 If the value is different, an "OK" string will be sent back.

14.16.2 Syntax :

Command syntax : ATI

| Command | Possible responses |
|--|--|
| ATIO <i>Note : Manufacturer and model identifications</i> | WAVECOM MODEM 900P OK <i>Note : GSM 900 MHz primary band</i> |
| ATI3 <i>Note : Revision identification</i> | 310_G250.51 806216 032199 17:04 OK <i>Note : Software release 3.10 ,revision 51 generated on the 21st of March 1999</i> |
| ATi6 <i>Note : Modem data features</i> | DATA RATES: AUTOBAUD,300,1200,1200/75,2400,4800,9600,14400 DATA MODES : T/NT,ASYNCHRONOUS FAX CLASS 1,2 OK <i>Note : Done</i> |
| ATi7 <i>Note : Modem voice features</i> | SPEECH CODINGS: FR,EFR,HR OK <i>Note : Done</i> |

14.17 Data / Commands Multiplexing +WMUX

14.17.1 Description

This **specific** command allows to manage the data / AT commands multiplexing mode. See appendix 18.13 for the Data / Commands multiplexing protocol description.

14.17.2 Syntax

Command syntax AT+WMUX=<mode>

| Command | Possible responses |
|--|---|
| AT+WMUX=? | +WMUX: (0-1) OK |
| AT+WMUX? | +WMUX: 0 OK <i>Data / Commands multiplexing disabled.</i> |
| AT+WMUX=1 <i>Enable Data / Commands multiplexing.</i> | OK |

14.17.3 Defined values

<mode>

0: Multiplexing disabled. When the product is online (data communication in progress), no AT command can be used (default).

1: Multiplexing enabled. Data flows and AT commands are multiplexed while in online mode (data communication in progress).

15 Specific AT commands

15.1 Cell environment description +CCED

15.1.1 Description :

This command can be used by the application to retrieve the parameters of the main cell and of up to six neighbouring cells.

There are two possible methods for the external application to ascertain these cell parameters: on request by the application or automatically by the product every 5 seconds.

Automatic mode is not supported during registration.

15.1.2 Syntax :

Command syntax: AT+CCED=<mode>[, <requested dump>]

15.1.3 Defined values :

<mode>

0: One shot requested

1: Automatic shots requested

2: Stop automatic shots

<requested dump>

1: Main Cell : **if the Cell Identity is available** MCC, MNC, LAC, CI, BSIC, BCCH Freq (absolute), RxLev, RxLev Full, RxLev Sub, RxQual, RxQual Full, RxQual Sub,Idle TS **if the Cell Identity is not available** MCC, MNC, LAC, BSIC, BCCH Freq (absolute), RxLev, RxLev Full, RxLev Sub, RxQual, RxQual Full, RxQual Sub,Idle TS

2: Neighbour1 to Neighbour6 : **if the Cell Identity is available** MCC, MNC, LAC, CI, BSIC, BCCH Freq (absolute), RxLev **if the Cell Identity is not available** MCC, MNC, LAC,, BSIC, BCCH Freq (absolute), RxLev

4: Timing Advance

Combination (addition of the values) of the requested dump is supported.

Note that in idle mode, only RxLev measurements (on the main cell and on the neighbouring cells) are made. The value of these RxLev is set in the RxLev Full field for the main cell.

The response will be:

+CCED :<value>, ... , <value>

OK

Where <value> is the ASCII string of the values (in decimal form except the LAC and CI values which are in hexadecimal form) of the parameters. If a field cannot be measured – or has no sense – the parameter is not filled in (two consecutive commas are then found).

If the <requested dump> parameter is absent, that of the last +CCED command (or 15 by default) will be used.

Values of MCC/MNC are set to 0 in the case of "No service".

15.2 Automatic RxLev indication +CCED

15.2.1 Description :

The CCED command has been extended to indicate the *received signal strength indication* (rssi) of the main cell. The command principle has not changed.

15.2.2 Syntax :

Command Syntax: AT+CCED=<mode>[, <requested dump>]

15.2.3 Defined values :

<mode>

0: One shot requested

1: Automatic shots requested

2: Stop automatic shots

<requested dump>

8: Main cell RSSI indications (RxLev) from 0 to 31

The response will be a +CSQ response and not a +CCED response. The 07.07 format for +CSQ is respected. The <ber> is not evaluated by this command, so the <ber> value will always be 99.

+CSQ :<rssi>, 99

OK

This +CSQ response, when automatic shots are selected, is sent every time the <rssi> measured by the product changes. Automatic shots are supported in idle mode and during communication.

Combination (addition of the values) of the requested dump (1,2,4,8) are supported but the activation or deactivation of this flow (8) does not affect the other flows. Both +CCED and +CSQ responses may then be generated.

If the <requested dump> parameter is absent, the last +CCED command parameter (or 15 by default) will be used.

15.3 General Indications +WIND

15.3.1 Description :

Wavecom has introduced a general mechanism to send unsolicited non-standardized indications to the application. The identified unsolicited non-standardized indications are:

- indication of a physical change on the SIM detect pin from the connector (meaning SIM inserted, SIM removed)
- indication during mobile originated call setup that the calling party is ringing.
- Indication of the availability of the product to receive AT commands after boot.

For each of these indications, a "bit flow" has to be indicated.

15.3.2 Syntax :

Command syntax: AT+WIND= <IndLevel >

15.3.3 Defined values :

<IndLevel>

- 1 (bit-0): Hardware SIM Insert / Remove indications (Rack open/close) or SIM presence after software reset
- 2 (bit-1): Calling party alert indication
- 4 (bit-2) : Product is ready to process AT commands (except phonebooks, AOC, SMS), but still in emergency mode.
- 8 (bit-3): Indication that the product is ready to process all AT commands, at the end of init or after swapping to ADN in case of FDN configuration
- 16 (bit-4): Indication that a new call identifier has been created (after an ATD command, +CCWA indication)
- 32 (bit-5): Indication that an active, held or waiting call has been released by network or other party
- 64 (bit-6): Network service available indication
- 128 (bit-7): Network lost indication
- 256 (bit-8): Audio ON indication
- 512 (bit-9): SIM Phonebooks reload status
- 1024 (bit-10) Sim phonebooks checksum indication
- 2048 (bit-11) Interruption indication (only if FTR_INT is activated)

If <IndLevel> is equal to 0 (default value), no unsolicited "+WIND: <IndNb>" will occur.

Combination (addition of the values) is used to allow more than one indication flow.

$$0 \geq \text{IndLevel} \leq 4095$$

The response is OK if the values are in the previous range.

The supported events are:

<event>

- 0: The SIM presence pin has been detected as "SIM removed" (depending on 0 bit flow)
- 1: The SIM presence pin has been detected as "SIM inserted"
- 2: Calling party is alerting
- 3: Product is ready to process AT commands (except phonebooks, AOC, SMS), at init or after AT+CFUN=1
- 4: Product is ready to process all AT commands, end of phonebook init or swap (FDN to ADN)
- 5: Call <idx> has been created (after ATD or +CCWA...)
- 6: Call <idx> has been released, after a NO CARRIER, a +CSSU: 5 indication, or after the release of a call waiting
- 7 : The network service is available for an emergency call.
- 8: The network is lost.
- 9: Audio ON.
- 10: Show reload status of each SIM phonebook after init phase (after Power-ON or SIM insertion).
- 11: Show the checksum of Sim phonebooks after loading them
- 12: An interruption has occurred

The AT+WIND? command is supported and indicates the <allowed bit flows>. AT+WIND settings are automatically stored in non volatile memory (EEPROM). This means the &W command does not need to be used and the selected flows are always activated after boot.

Default value is 0: no flow activated, no indication.

AT+WIND=? gives the possible value range (0-1023)

The unsolicited response will then be:

+WIND : <event> [,<idx>]

<idx>: Call identifier, defined in +CLCC command.

Or for event 10:

+WIND: <event>,<phonebook>,<status>,...,<phonebook>,<status>

<phonebook>: SIM phonebook ("SM", "FD", "ON", "SN", "EN")

<status>:

0: Not Reloaded from SIM (no change since last init or SIM remove)

1: Reloaded from SIM to internal memory (at least one entry has changed)

Or for event 11:

+WIND: <event>,["<checksum of SM>"],["<checksum of FD>"],["<checksum of ON>"],["<checksum of SN>"],["<checksum of EN>"],["<checksum of LD>"]

<checksum>: 128-bit "fingerprint" of the phonebook.

Note: If the service of the phonebook is not loaded or not present, the checksum is not displayed and two comas without checksum are displayed (,,).

15.4 Analog digital converters measurements +ADC

15.4.1 Description :

This command gets the (DC level * 1024) of ADC A and ADC B (these voltages are coded on 10 bits, see hardware specifications) or the (DC level * 1024) of ADC A, ADC B and ADC C (voltages coded on 10 bits) depending on the ADC mode.

For ADC A, the value returned includes the resistor bridge. These values are updated every 10 seconds.

This command allows ADC mode to be set. Mode 0 displays the values of the first 2 converters on 10 bits, mode 1 also displays the values of the 3 converters coded on 10 bits.

15.4.2 Syntax :

Command syntax : AT+ADC

| Command | Possible responses |
|---|--|
| AT+ADC=<n> | |
| AT+ADC=0 <i>Note : Select 2 converters (mode 0)</i> | OK <i>Note : 2 converters mode selected</i> |
| AT+ADC=1 <i>Note : Select 3 converters (mode 1)</i> | OK <i>Note : 3 converters mode selected</i> |
| AT+ADC=? <i>Note : Ask for the list of possible values</i> | +ADC: (0-1) <i>Note : possible values 0 or 1</i> |
| AT+ADC? <i>Note : Ask for the current values of converters in mode 0</i> | +ADC: 500,412 OK <i>Note : Adc A, Adc B on 10 bits</i> |
| AT+ADC? <i>Note : Ask for the current values of converters in mode 1</i> | +ADC: 712,698,997 OK <i>Note: Adc A, Adc B, Adc C on 10 bits</i> |

15.5 Mobile Equipment event reporting +CMER

15.5.1 Description :

This command enables or disables sending of unsolicited result codes in the case of a key press.

15.5.2 Syntax :

Command Syntax: AT+CMER=<mode>,<keyp>,<disp>,<ind>,<bfr>
The parameters <mode>, <disp>, <ind> and <bfr> are not handled.

15.5.3 Defined values :

<keyp> (keypad) :

0: No keypad event reporting.

1: Keypad event reporting are routed using unsolicited code : +CKEV : <key>, <press>

only those key pressings, which are not caused by +CKPD are indicated.

2 : Keypad event reporting are routed using unsolicited code : +CKEV : <key>, <press>

all key pressings ar indicated.

Note: As AT software does not manage the emulation of key press, the values 2 and 3 lead to the same results.

<press>

1: key press

0: key release

<key> : Keyboard map is (5,5)

| | | | | |
|----|----|----|----|----|
| 0 | 1 | 2 | 3 | 4 |
| 5 | 6 | 7 | 8 | 9 |
| 10 | 11 | 12 | 13 | 14 |
| 15 | 16 | 17 | 18 | 19 |
| 20 | 21 | 22 | 23 | 24 |

<key> : Keyboard map is (5,5)

| | | | | |
|----|----|----|----|----|
| 0 | 1 | 2 | 3 | 4 |
| 5 | 6 | 7 | 8 | 9 |
| 10 | 11 | 12 | 13 | 14 |
| 15 | 16 | 17 | 18 | 19 |
| 20 | 21 | 22 | 23 | 24 |

15.6 Read Language Preference +WLPR

15.6.1 Description :

Read a Language Preference value of EF-LP. The first indices should have the highest priority.

15.6.2 Syntax :

Command syntax: AT+WLPR= <index >

Response syntax: +WLPR: <value>

| Command | Possible responses |
|---|--|
| AT+WLPR? <i>Note : Read command</i> | +WLPR: 4 OK <i>Note : Four language preferences are available in EF-LP</i> |
| AT+WLPR=1 <i>Note : Read first EF-LP index value</i> | +WLPR: 5 OK <i>Note : Language preference is 5</i> |

15.7 Write Language Preference +WLPW

15.7.1 Description :

Write a Language Preference value in EF-LP

15.7.2 Syntax :

Command syntax: AT+WLPW=<index >,<value>

Response syntax: OK or +CME ERROR: <err>

| Command | Possible responses |
|---|---|
| AT+WLPW=1,5 <i>Note : Write Lang Pref equal to 5 in EF-LP with index 1</i> | OK <i>Note : EF-LP correctly updated</i> |

Exemple of value for language: (see 23038)

| | |
|----|------------|
| 0 | German |
| 1 | English |
| 2 | Italian |
| 3 | French |
| 4 | Spanish |
| 5 | Dutch |
| 6 | Swedish |
| 7 | Danish |
| 8 | Portuguese |
| 9 | Finnish |
| 10 | Norwegian |
| 11 | Greek |
| 12 | Turkish |
| 13 | Hungarian |
| 14 | Polish |
| 32 | Czech |
| 33 | Hebrew |
| 34 | Arabic |
| 35 | Russian |
| 36 | Icelandic |

15.8 Read GPIO value +WIOR

15.8.1 Description

Read the requested GPI or GPIO pin value.

Note :

- by default (e.g. after a reset), the I/O ports configuration is set by the **+WIOM** command.
- This command is allowed only on a Gpio not allocated by an Open-AT embedded application or for I2C soft bus.

15.8.2 Syntax

Command syntax: AT+WIOR=<index>

Response syntax: +WIOR: <value>

| Command | Possible responses |
|---|---|
| AT+WIOR=0 <i>Read I/O (number 0) value</i> | +WIOR: 0 OK <i>GPIO number 0 is reset</i> |

15.8.3 Defined values

<index>

Eight I/O ports are available. The <index> value is between 0 and 7.

<value>

0: I/O port number <index> is reset.

1: I/O port number <index> is set.

15.9 Write GPIO value +WIOW

15.9.1 Description

Set the requested GPO or GPIO pin value.

Note :

- by default (after a reset), the I/O ports configuration is set by the **+WIOM** command.
- This command is allowed only on a Gpio not allocated by the Open-AT embedded application or for I2C soft bus.

15.9.2 Syntax

Command syntax: AT+WIOW=<index >,<value>

| Command | Possible responses |
|--|------------------------------------|
| AT+WIOW=2,0 <i>Reset I/O (number 2)</i> | OK <i>GPIO value is written</i> |

15.9.3 Defined values

<index>

Eight I/O ports are available. The <index> value is between 0 and 7.

<value>

0: I/O port number <index> is reset.

1: I/O port number <index> is set.

15.10 Input/Output Management +WIOM

15.10.1 Description

This **specific** command allows to set the default GPIOs configuration (input or output) after reset, and each GPIO default value (if set as an output) after reset.

Note :

- This command is allowed only on a Gpio not allocated by the Open-AT embedded application or for I2C soft bus.

15.10.2 Syntax

Command Syntax AT+WIOM=[<GpioDir>],[<GpioVal>]

| Command | Possible responses |
|-----------|--|
| AT+WIOM? | +WIOM: 255,0 OK <i>On reset, all GPIOs are set to 0, as an output.</i> |
| AT+WIOM=? | +WIOM: (0-255),(0-255) OK <i>Range allowed for the parameters.</i> |

| | |
|--|----------------------|
| AT+WIOM=254 <i>Set GPIO 0 as an input, and all others as outputs.</i> | OK |
| AT+WIOM=,128 <i>Set GPIO 7 default output value to 1.</i> | OK |
| AT+WIOM? | +WIOM: 254,128 OK |

15.10.3 Defined values

<GpioDir>

Bit table parameter.

Allowed range : [0 ; 255],

Default value : 255 (all GPIOs set as outputs).

Each bit gives the corresponding GPIO default direction : 0 for input, 1 for output.

<GpioVal>

Bit table parameter.

Allowed range : [0 ; 255],

Default value : 0 (all GPIOs reset to 0).

Each bit gives the corresponding GPIO default value.

If it is set as an output : 0 for reset, 1 for set.

The GPIOs set as inputs by the <GpioDir> parameter are not affected by the value set by the <GpioVal> parameter.

Notes :

- <GpioDir> bit values for GPI and GPO are ignored.
- <GpioVal> bit values for GPI are ignored.
- Here is the corresponding table between Module Gpio Pin Names and AT commands numbers :

| AT Commands number | Wismo Quik Pin Names | Wismo Pac Pin Names |
|--------------------|----------------------|---------------------|
| 0 | GPIO 0 | GPIO 0 |
| 1 | GPO 1 | GPI |
| 2 | GPO 2 | GPIO 2 |
| 3 | GPI | GPIO 3 |
| 4 | GPIO 4 | GPIO 4 |
| 5 | GPIO 5 | GPIO 5 |
| 6 | (no gpio affected) | (no gpio affected) |
| 7 | (no gpio affected) | (no gpio affected) |

15.11 Abort command +WAC

15.11.1 Description

This **specific** command allows SMS, SS and PLMN selection related commands to be aborted.

15.11.2 Syntax

Command syntax: AT+WAC

| Command Syntax | Return |
|----------------|--------|
| AT+WAC | |
| AT+WAC=? | OK |
| AT+WAC? | OK |

Example :

| Command | Possible responses |
|--|---------------------|
| AT+COPS=? <i>Note : Available PLMN</i> | |
| AT+WAC <i>Note : Abort the request of PLMN list</i> | OK <i>Note :</i> |

15.12 Play tone +WTONE

15.12.1 Description :

This **specific** command allows a tone to be played on the current speaker or on the buzzer. Frequency, gain and duration can be set.

15.12.2 Syntax :

Command syntax: AT+WTONE=<mode>[,<dest>,<freq>,<gain>,<duration>]

Response syntax: OK or +CME ERROR: <err>

| Command | Possible responses |
|--|--------------------------|
| AT+WTONE=1,1,300,9,50 <i>Note : Play a tone</i> | OK <i>Note : Done</i> |
| AT+WTONE=0 <i>Note : Stop playing</i> | OK <i>Note : Done</i> |
| AT+WTONE=? <i>Note : Test command</i> | OK <i>Note : Done</i> |
| AT+WTONE? <i>Note : Current value</i> | ERROR <i>Note :</i> |

15.12.3 Defined values :

<mode>

0: Stop playing.

1: Play a tone

<dest>: This parameter sets the destination (mandatory if <mode>=1)

<dest>

1: Speaker

2: Buzzer

<freq>: This parameter sets tone frequency (in Hz) (mandatory if <mode>=1). If <dest> is the speaker, the range is between 1Hz and 3999Hz. If <dest> is the buzzer, the range is between 1Hz and 50000Hz.

<gain> (0-15): This parameter sets the tone gain. The default value is 9.

| <gain> | Speaker (db) | Buzzer (db) |
|--------|--------------|-------------|
| 0 | 0 | -0.25 |
| 1 | -0.5 | -0.5 |
| 2 | -1 | -1 |
| 3 | -1.5 | -1.5 |
| 4 | -2 | -2 |
| 5 | -3 | -3 |
| 6 | -6 | -6 |
| 7 | -9 | -9 |
| 8 | -12 | -12 |
| 9 | -15 | -15 |
| 10 | -18 | -18 |
| 11 | -24 | -24 |
| 12 | -30 | -30 |
| 13 | -36 | -40 |
| 14 | -42 | -infinite |
| 15 | -infinite | -infinite |

<duration> (0-50): This parameter sets tone duration (unit of 100 ms). When this parameter is equal to 0 (default value), the duration is infinite, and the tone can be stopped by AT+WTONE=0.

15.13 Play DTMF tone +WDTMF

15.13.1 Description :

This **specific** command allows a DTMF tone to be played on the current speaker. DTMF, gain and duration can be set. This command is only used to play a DTMF tone. To send a DTMF over the GSM network, use the +VTS command.

15.13.2 Syntax :

Command syntax: AT+WDTMF=<mode>[,<dtmf>,<gain>,<duration>]

Response syntax: OK or +CME ERROR: <err>

| Command | Possible responses |
|--|---|
| AT+WDTMF=1,"*",9,100 <i>Note : Play a DTMF tone</i> | OK <i>Note : Done</i> |
| AT+WDTMF=0 <i>Note : Stop playing</i> | OK <i>Note : Done</i> |
| AT+WDTMF=? <i>Note : Test command</i> | +WDTMF: (0-1),(0-9,*,#,A,B,C,D),(0-15),(0-50) OK <i>Note : Done</i> |
| AT+WDTMF? <i>Note : Current value</i> | ERROR <i>Note :</i> |

15.13.3 Defined values :

<mode>

0: Stop playing.

1: Play a DTMF tone

<dtmf>:

This parameter sets the DTMF to play in {0-9,*,#,A,B,C,D} (mandatory if <mode>=1)

<gain> (0-15):

This parameter sets tone gain. The values are identical to those of the +WTONE (speaker) command. By default, the value is 9.

<duration> (0-50):

This parameter sets the tone duration (unit of 100 ms). When this parameter is 0 (default value), the duration is infinite, and the DTMF tone can be stopped by AT+WDTMF=0.

15.14 Wavecom Downloading +WDWL

15.14.1 Description :

This **specific** command switches the product to download mode. Downloading is performed using the 1K-XMODEM protocol.

15.14.2 Syntax :

Command syntax: AT+WDWL

| Command | Possible responses |
|---|---|
| AT+WDWL <i>Note : Switch on downloading mode</i> | +WDWL: 0 <i>Note : Start the downloading</i> |
| | ... <i>Note : Downloading in progress</i> |
| | AT+CFUN=1 <i>Note : Reset the product at the end</i> |
| OK <i>Note :</i> | |

15.15 Wavecom Voice Rate +WVR

15.15.1 Description :

This **specific** command allows the voice rate for bearer voice to be configured (available for outgoing calls only).

15.15.2 Syntax :

Command syntax : AT+WVR=<n>

| Command Syntax | Return |
|----------------|--|
| AT+WVR=<n> | |
| AT+WVR=? | If Half Rate available. +WVR: (0,2,3) If EFR available. +WVR: (0,1) If HR and EFR not available +WVR: (0) If HR and EFR available +WVR: (0-5) |
| AT+WVR? | +WVR: <n> |

| Command | Possible responses |
|---|--|
| AT+WVR=1 <i>Note : Configure voice type FR and EFR</i> | OK <i>Note : Bearer is configured</i> |
| AT+WVR=6 <i>Syntax error</i> | +CME ERROR: 3 <i>Note :</i> |
| AT+WVR? <i>Note : Ask the current value</i> | +WVR: 1 OK <i>Note :</i> |
| OK <i>Note :</i> | |

15.15.3 Defined values :

<n> : Voice coding type.

<n>

0: FR

1: FR and EFR

2: FR, HR with HR preferred

3: HR, FR with FR preferred

4: EFR,HR with HR preferred

5: HR,EFR with EFR preferred.

15.16 Data Rate +WDR

15.16.1 Description :

This **specific** command allows the data rate for bearer data to be configured (available for outgoing calls only).

15.16.2 Syntax :

Command syntax : AT+WDR=<n>

| Command Syntax | Return |
|----------------|---|
| AT+WDR=<n> | |
| AT+WDR=? | If Half Rate available. +WDR: (0-2) Else +WDR: (0) |
| AT+WDR? | +WDR: <n> |

| Command | Possible responses |
|---|--|
| AT+WDR=1 <i>Note : Configure voice type FR,HR with HR preferred.</i> | OK <i>Note : Bearer is configured</i> |
| AT+WDR=3 <i>Syntax error</i> | +CME ERROR: 3 <i>Note :</i> |
| AT+WDR? <i>Note : Ask the current value</i> | +WDR: 1 OK <i>Note :</i> |
| OK <i>Note :</i> | |

15.16.3 Defined values :

<n>: Data coding type.

<n>

0: FR

1: FR, HR with HR preferred

2: HR, FR with FR preferred

15.17 Hardware Version +WHWV

15.17.1 Description :

This **specific** command gets the hardware version.

15.17.2 Syntax :

Command syntax : AT+WHWV

| Command | Possible responses |
|---|---|
| AT+WHWV <i>Note : Request Hardware Version</i> | Hardware Version 4.14 OK <i>Note : Hardware version is 4.14</i> |
| AT+WHWV <i>Note : Request Hardware Version</i> | Hardware Version --- OK <i>Note : No hardware version available</i> |

15.18 Date of Production +WDOP**15.18.1 Description :**

This **specific** command gets the date of production. Format of the date is Week/Year.

15.18.2 Syntax :

Command syntax : AT+WDOP

| Command | Possible responses |
|---|--|
| AT+WDOP <i>Note : Request Date of Production</i> | Production date (W/Y): 01/2000 OK <i>Note : Date of production is WEEK: 01 / YEAR: 2000 (1st week of year 2000)</i> |
| AT+WDOP <i>Note : Request Date of Production</i> | Production date (W/Y): --/---- OK <i>Note : No date of production available</i> |

15.19 Wavecom Select Voice Gain +WSVG**15.19.1 Description :**

The product has 2 voice gain controllers, this **specific** command allows the microphone gain controller to be selected.

15.19.2 Syntax :

Command syntax : AT+WSVG = <n>

| Command | Possible responses |
|--|--|
| AT+WSVG=<n> | |
| AT+WSVG=0 <i>Note : Select Controller 1 (Default)</i> | OK <i>Note : Controller 1 selected</i> |
| AT+WSVG=1 <i>Note : Select Controller 2 (Default)</i> | OK <i>Note : Controller 2 selected</i> |
| AT+WSVG=? <i>Note : Get the list of possible values</i> | +WSVG: (0-1) <i>Note : possible values 0 or 1</i> |
| AT+WSVG? <i>Note : Get the current value</i> | +WSVG: 1 <i>Note : Controller 1 is selected</i> |

15.19.3 Defined values

<n> Controller

0: Controller 1 (Default)

1: Controller 2

15.20 Wavecom Status Request +WSTR

15.20.1 Description :

This **specific** command returns some operation status. It can be used for ex. to check the state of the initialisation sequence; the different values returned are Not started, Ongoing, Finished.

15.20.2 Syntax :

Command syntax: AT+WSTR=<status>

Response syntax: +WSTR: <status>,<value>

| Command | Possible responses |
|---|--|
| AT+WSTR=<status> | +WSTR :<status>,<value> |
| AT+WSTR=1 <i>Note : Select the status 1 (INIT SEQUENCE)</i> | +WSTR: 1,2 OK <i>Note : Init finished</i> |
| AT+WSTR=2 <i>Note : Select the status 2 (NETWORK STATUS)</i> | +WSTR: 2,1 OK <i>Note : The network is available</i> |
| AT+WSTR=? <i>Note : Ask the list of possible values</i> | +WSTR: (1-2) <i>Note : possible values : 1, 2</i> |

15.20.3 Defined values

<status> 1 Initialisation sequence

<value>

0: Not started

1: On going

2: Finished

<status> 2 Network status

<value>

0: No network

1: Network available

15.21 Wavecom Scan +WSCAN

15.21.1 Description :

This **specific** command displays the received signal strength indication (<rss>) for a specified frequency (in absolute format).

This command is not allowed during communication.

15.21.2 Syntax :

Command syntax: AT+WSCAN=<absolute frequency>

Response syntax: +WSCAN: <rss>

| Command | Possible responses |
|---|--|
| AT+WSCAN=50 <i>Note : Request <rss> of absolute frequency 50</i> | +WSCAN: 23 OK <i>Note : <rss> is 23.</i> |
| AT+WSCAN=1025 <i>Note : Request power of absolute frequency 1025</i> | CME ERROR: 3 <i>Note : 1025 is not a valid absolute frequency</i> |

15.21.3 Defined values

<absolute frequency> frequency in absolute format

<rssi>

- 0: -113 dBm or less
- 1: -111 dBm
- 2...30: -109 to -53 dBm
- 31: -51dBm or greater
- 99: not known or not detectable

15.22 Wavecom Ring Indicator Mode +WRIM

15.22.1 Description :

This **specific** command sets or returns the state of the Ring Indicator Mode. In pulse RI mode, an electrical pulse is sent on the Ring Indicator signal just before sending any unsolicited AT response in order not to lose AT responses when client tasks are in sleep state. Still in RI mode, when receiving incoming calls, electrical pulses are sent on the RI signal. In up-down RI mode, no pulses are sent before unsolicited AT response, and up-down signals are sent when receiving an incoming call.

15.22.2 Syntax :

Command syntax: AT+WRIM=<n>

| Command | Possible responses |
|---|--|
| AT+WRIM=<n> | OK |
| AT+WRIM=0 | OK |
| <i>Note : Select up-down RI mode</i> | <i>Note : up-down RI mode selected</i> |
| AT+WRIM=1 | OK |
| <i>Note : Select pulse RI mode</i> | <i>Note : pulse RI mode selected</i> |
| AT+WRIM=? | +WRIM: (0-1) OK |
| <i>Note : Ask the list of possible values</i> | <i>Note : possible values 0 or 1</i> |
| AT+WRIM? | +WRIM: 1 OK |
| <i>Note : Ask the current value</i> | <i>Note : current RI mode is pulse RI.</i> |

15.22.3 Defined values

<n>

- 0: up-down RI mode
- 1: pulse RI mode

15.23 Wavecom 32kHz Power down Mode +W32K

15.23.1 Description :

This **specific** command allows the 32kHz power down mode to be enabled or disabled.

When power down mode is entered, the product uses a 32kHz internal clock during inactivity stages.

When enabled, power down mode is active after 1 to 15 minutes.

For additional information on power down mode, see Appendix F.

15.23.2 Syntax :

Command syntax : AT+W32K=<mode>

| Command | Possible responses |
|--|---|
| AT+W32K=1 <i>Note : Enable 32kHz power down mode</i> | OK <i>Note : 32kHz power down mode is enabled</i> |
| AT+W32K=0 <i>Note : Disable 32kHz power down mode</i> | OK <i>Note : 32kHz power down mode is disabled</i> |

15.23.3 Defined values

<mode>

0: Disable 32kHz powerdown mode

1: Enable 32kHz powerdown mode

15.24 Wavecom Change Default Melody +WCDM

15.24.1 Description :

This **specific** command allows a manufacturer specific melody to be selected.

This default melody will be played for any new incoming voice call, either on the buzzer or on the speaker. If melody 0 is selected, no melody will be played.

15.24.2 Syntax :

Command syntax : AT+WCDM=<melody>,<player>

| Command | Possible responses |
|---|--|
| AT+WCDM=0 <i>Note : Select no melody</i> | OK |
| AT+WCDM=5 <i>Note : Select melody n°5</i> | OK |
| AT+WCDM? <i>Note : Indicate the current melody</i> | +WCDM: 5,0 OK <i>Note : Melody n°5 is currently selected, and the buzzer is selected to play it.</i> |
| | RING <i>Note : An incoming call occurs, and the melody n°5 is played on the buzzer.</i> |
| AT+WCDM=,1 <i>Note : Select the speaker to play the melody on.</i> | OK |
| AT+WCDM? | +WCDM: 5,1 OK <i>Note : Now the speaker is selected to play the melody if an incoming call occurs.</i> |

15.24.3 Defined values

<melody>

0: No melody (**default**)

1...10: Melody 1 to 10

<player>

0: Melody n°<melody> will be played on the buzzer for any new incoming voice call. (**default**)

1: Melody n°<melody> will be played on the speaker for any new incoming voice call.

15.25 Wavecom Software version +WSSW

15.25.1 Description :

This **specific** command displays some internal software reference.

15.25.2 Syntax :

Command syntax : AT+WSSW

| Command | Possible responses |
|---|---|
| AT+WSSW <i>Note : Get Software version</i> | A00_00gm.2c 000000008F5DC6EA OK <i>Note : internal software information</i> |

15.26 Wavecom Custom Character Set +WCCS

15.26.1 Description :

This **specific** command allows to edit and display the custom character set tables. The "CUSTOM" mode of +CSCS and the +WPCS commands use this character set. In this mode, when the user enters a string, this string is converted into GSM alphabet using the Custom To GSM table. In a similar way, when the user requests a string display, the string is converted from GSM alphabet using the GSM To Custom table.

In edition mode, the edition session is terminated by <ctrl-Z>, or aborted by <ESC>. Only hexadecimal characters ('0'...'9', 'A'...'F') can be used. The number of characters entered must equal the edition range requested, otherwise the command will terminate with a "+CME ERROR: 3" result.

15.26.2 Syntax :

Command syntax : AT+WCCS=<mode>,<table>,<char 1>[,<char 2>]

| Command | Possible responses |
|--|---|
| AT+WCCS=0,0,120,130 <i>Note : Display from character 120 to character 130 of the Custom To GSM conversion table</i> | +WCCS: 11, 78797A2020202020097E05 OK <i>Note : 11 characters displayed</i> |
| AT+WCCS=1,0,115<CR> 20<ctrl-Z> <i>Note : Edit character 115 of the Custom To GSM conversion table</i> | OK <i>Note : Edition successful</i> |
| AT+WCCS=1,1,0,4<CR> 40A324A5E8<ctrl-Z> <i>Note : Edit the 5 first characters of the GSM To Custom conversion table</i> | OK <i>Note : Edition successful</i> |
| AT+WCCS=1,1,200 <i>Note : Edit character 200 of GSM To Custom conversion table</i> | +CME ERROR: 3 <i>Note : Index out of range</i> |

15.26.3 Defined values

<mode>

- 0: Display the table
- 1: Edit the table

<table>

- 0: Custom To GSM conversion table
- 1: GSM To Custom conversion table

<char 1>, <char 2> Character range to display/edit. If only <char 1> is present, only this char is displayed/edited.

0...127: for GSM To Custom conversion table

0...255: for Custom To GSM conversion table

See section 19.2 for informative examples on phonebooks.

15.27 Wavecom LoCK +WLCK

15.27.1 Description :

This **specific** command allows the ME to be locked on a specific network operator.

Nota: Test SIM cards (with MCC=001 & MNC=01) doesn't check these locks.

15.27.2 Syntax :

Command syntax: AT+WLCK=<fac>,<passwd>,<NetId>[,<GID1>[,GID2]]
[,<CnlType>[,<CnlData>]]

Response syntax: +WLCK: <status>

| Command | Possible responses |
|--|--|
| AT+WLCK="PN",12345678,20810 <i>Note : Activate network lock on SFR (208, 10)</i> | OK <i>Note : Network lock activated</i> |
| AT+WLCK="PS",12345678,208105923568974 <i>Note : Activate SIM lock</i> | OK <i>Note : SIM lock activated</i> |
| AT+WLCK="PU",12345678,2081035 <i>Note : Activate Network Subset lock on SFR (208, 10, 35).</i> | OK <i>Note : Network Subset lock activated</i> |
| AT+WLCK="PU",12345678,20810 | +CME ERROR: 3 <i>Note: Need 7 digits of IMSI to perform a service provider lock</i> |
| AT+WLCK="PP",12345678,20810,"E5" <i>Note : Activate Service Provider lock on SFR (208, 10) and GID1 (0xE5).</i> | OK <i>Note : Service Provider lock activated.</i> |
| AT+WLCK="PC",12345678,20810,"E5","10" <i>Note : Activate Corporate lock on SFR (208, 10), GID1 (0xE5) and GID2 (0x10).</i> | OK <i>Note : Corporate lock activated.</i> |
| AT+WLCK="PN",12345678,20810,0 <i>Note : Activate Network lock on SFR (208, 10) using co-operative network list from SIM file EFCNL (must be present in SIM)</i> | OK <i>Note : Network lock activated on SFR and co-operative network list present in SIM</i> |
| AT+WLCK="PN",12345678,20801,1,"02F802FFFFFF02F801FFFFFF" <i>Note : Activate Network lock on F ORANGE (208, 01) with manual co-operative network list including SFR (208, 10) and Bouygues Telecom (208, 20)</i> | OK <i>Note : Network lock activated on F ORANGE (primary network), SFR and Bouygues Telecom (co-operative networks)</i> |

The following **<fac>** values are supported :

- "PS": SIM lock facility with a 8 digits password (PCK).
- "PN": Network lock with a 8 digits password (NCK).
- "PU": Network subset lock with a 8 digits password (NSCK).
- "PP": Service provider lock with a 8 digits password (SPCK).
- "PC": Corporate lock with a 8 digits password (CCK).

<CnlType> Type of lock for co-operative network list (CNL)
0 : Automatic (co-operative network list retrieved from EFCNL SIM file)
 Note:
EFCNL file must be present in SIM to use automatic mode.
1 : Manual (co-operative network list is given in the <CnlData> parameter)

<CnlData> Co-operative network list (hexa string type) using same format as in EFCNL SIM file (ETSI GSM 11.11 or 3GPP 04.08).
 Note:
Only if <CnlType> = 1

15.28 CPHS command +CPHS

15.28.1 Description :

This **specific** command is used to activate, deactivate or interrogate a CPHS feature (e.g. Voice Mail Indicator, Mail Box Number...)

Note :

This command may answer +CME ERROR: 3 if the CPHS feature is disabled (cf. +WFM command), or if the SIM card does not support this CPHS feature.

15.28.2 Syntax

Command syntax : AT+CPHS=<Mode>,<FctId>

| Command | Possible responses |
|------------------------|--|
| AT+CPHS=<Mode>,<FctId> | OK +CME ERROR: 3 |
| AT+CPHS? | +CPHS: <FctId1>,<Status><CR<LF> +CPHS: <FctId2>,<Status><CR<LF> ... +CPHS: <FctIdn>,<Status><CR<LF> OK |
| AT+CPHS=? | OK |

15.28.3 Defined values:

<Mode>

- 0**: Deactivate a CPHS feature
- 1**: Activate a CPHS feature
- 2**: Interrogate a CPHS status

<FctId>

- 1**: Voice Mail Indicator
- 2**: Mail Box Number

<Status>

0: CPHS feature disabled

1: CPHS feature enabled

**15.29 Unsolicited result : Wavecom Voice Mail Indicator
+WVMI****15.29.1 Description :**

This unsolicited indication gives the status of the LINE 1, LINE 2, FAX or DATA mailbox.

Syntax : +WVMI: <Lineld>,<Status>

Option :

<Lineld>

1: Line 1

2: Line 2

3: FAX

4: DATA

<Status>

0: No message waiting.

1: At least one message is waiting

15.29.2 Example

| | |
|--|---|
| AT+CPHS? | <i>Interrogate the status of CPHS functionality</i> |
| +CPHS: 1,0 | <i>The voice mail indicator functionality is deactivated</i> |
| +CPHS: 2,0 | <i>The mail box number functionality is deactivated</i> |
| OK | |
| AT+CPHS=3,1 | <i>Syntax error</i> |
| +CME ERROR: 3 | |
| AT+CPHS=1,1 | <i>Activate the voice mail indicator functionality</i> |
| OK | |
| AT+CPHS? | <i>Interrogate the status of CPHS functionality</i> |
| +CPHS: 1,1 | <i>The voice mail indicator functionality is activated</i> |
| +CPHS: 2,0 | <i>The mail box number functionality is deactivated</i> |
| OK | |
| *** the message box contains 1 message **** | |
| +WVMI: 1,1 | <i>A message is waiting on Line 1</i> |
| **** The message box contains a second message *** | |
| +WVMI: 2,1 | <i>A message is waiting on Line 2</i> |
| AT+CPHS=2,1 | <i>Interrogate the status of voice mail indicator functionality</i> |
| +WVMI: 1,1 | <i>a message is waiting on LINE 1</i> |
| +WVMI: 2,1 | <i>a message is waiting on LINE 2</i> |
| +WVMI: 3,0 | <i>no FAX waiting</i> |
| +WVMI:4,0 | <i>no data waiting</i> |
| AT+CPHS=1,2 | <i>Activate the mail box number functionality</i> |
| OK | |
| AT+CPHS? | <i>Interrogate the status of CPHS functionality</i> |
| +CPHS: 1,1 | <i>The voice mail indicator functionality is activated</i> |
| +CPHS: 2,1 | <i>The mail box number functionality is activated</i> |
| OK | |
| AT+CPHS=2,2 | <i>Query current mail box numbers in SIM</i> |
| +WMBN: 1,"19254871234",129,1 | <i>Mail box number for Line 1</i> |
| +WMBN: 2,,0 | <i>Mail box number for Line 2</i> |
| +WMBN: 3,,0 | <i>Mail box number for Fax Line</i> |
| +WMBN: 4,,0 | <i>Mail box number for Data Line</i> |
| OK | <i>Only Line1 can be updated</i> |

15.30 Wavecom Battery Charge Management +WBCM

15.30.1 Description

This **specific** command allows the battery charging to be managed (start and stop the charge, enable or disable unsolicited +WBCI Battery Charge Indications), and sets the battery charge parameters.

15.30.2 Syntax

Command syntax : AT+WBCM=<Mode>[,<ChargeInd>][,<BattLevelMax>],<BattLevelMin>,<TPulseInCharge>,<TPulseOutCharge>,<BattIntRes>]]

| Command | Possible responses |
|--|--|
| AT+WBCM=0 <i>Stop the battery charging.</i> | OK |
| AT+WBCM=1,1 <i>Start the battery charging with charge indications.</i> | OK |
| | +WBCI: 2,4060 <i>Unsolicited charge indication: the current battery voltage is 4.06 V. See +WBCI description.</i> |
| AT+WBCM=1,0 <i>Start the battery charging without charge indications.</i> | OK |
| AT+WBCM=2 <i>Get the battery voltage during the charging.</i> | +WBCI: 2,4110 OK <i>See the description of +WBCI unsolicited response. The current battery voltage is 4.11 V.</i> |
| | +WBCI: 1 <i>The battery voltage has reached the max level. The battery is considered as charged and the charging is stopped.</i> |
| AT+WBCM? | +WBCM: 0,0,4200,3300,100,5000,0 OK <i>Current values.</i> |
| AT+WBCM=0,1 <i>Enable the battery charge unsolicited indications out of charge.</i> | OK |
| | +WBCI: 3,4195 <i>The current battery voltage is 4.195 V.</i> |
| AT+WBCM=3,0,3800,3000,500,3000,0 <i>Configure the battery charging parameters.</i> | OK |
| AT+WBCM=? <i>Get the parameters range.</i> | +WBCM: (0-3),(0-1),(4000-5000),(2800-3800), (100-10000),(100-10000),(0-255) OK |
| | +WBCI: 0 <i>The battery voltage has reached the min level. The battery is considered as discharged, and the product is turned off, as for the +CPOF command behavior.</i> |

15.30.3 Defined values

<Mode>

0: Stop the battery charging (default).

1: Start the battery charging.

- 2: Get the current battery voltage.
- 3: Set the battery charge parameters.

Note :

When <Mode> equals 0 or 1, only the <ChargeInd> parameter can be set; <Mode> 2 does not allow any additional parameter to be set; <Mode> 3 allows all others parameters to be set.

<ChargeInd>

- 0: Disable the battery charge unsolicited indications (default).
- 1: Enable the battery charge unsolicited indications (see +WBCI description).

<BattLevelMax> Maximum level for the battery voltage. When reached, the battery is considered as charged.
The allowed range is [4000 ; 5000] (in mV, default value is 4200)

<BattLevelMin> Minimum level for the battery voltage. When reached, the battery is considered as discharged, and the product is turned off (as with the +CPOF command behavior).
The allowed range is [2800 ; 3800] (in mV, default value is 3300)

Note :

The <BattLevelMax> and <BattLevelMin> parameters cannot be changed during the battery charging (when <Mode> = 1).

<TPulseInCharge> Time between pulses for the pulsed charge. The pulse duration lasts one second. When the battery charging is started with unsolicited charging indications (<ChargeInd> = 1), +WBCI responses are returned by the ME with a (<Pulse Time> (= 1s) + <TPulseInCharge>) period.
The allowed range is [100 ; 10000]. (in ms, default value is 100).

<TPulseOutCharge> Time between +WBCI unsolicited responses, when the battery charge is stopped with charging indications requested (<ChargeInd> = 1). The allowed range is [100 ; 10000] (in ms, default value is 5000).

<BattIntRes> Battery Internal Resistor. This parameter must be set to have correct values with +WBCI unsolicited results.
The allowed range is [0 ; 255] (in mΩ, default value is 0)

Note :

When the <BattIntRes> parameter is changed, the product must be reset to take the modification into account.

15.30.4 Unsolicited result : Wavecom Battery Charge Indication +WBCI

15.30.4.1 Description

This unsolicited indication returns information about the battery charge (Maximum Level reached, current battery voltage, etc).

15.30.4.2 Syntax

Unsolicited response syntax : +WBCI: <Status>[,<BattLevel>]

15.30.4.3 Defined values

<Status>

- 0: Minimum battery level reached - the battery is considered as discharged.
The product is turned off (as with the +CPOF command).
- 1: Maximum battery level reached - the battery is considered as charged.
The battery charging is stopped.
- 2: Battery currently in charge.
- 3: Battery currently out of charge.

Note :

<Status> 2 and 3 are solicited by the AT+WBCM=2 command, or unsolicited when the <ChargeInd> parameter of the +WBCM command is set to 1. With these <Status> values, the <BattLevel> parameter is also present.

<BattLevel> Current battery voltage during or out of the charging.
The possible range is [2800 ; 5000]. (in mV)

15.31 Features Management +WFM

15.31.1 Description

This **specific** command allows some features to be enabled or disabled.

Note :

After a modification, the changes will be taken into account only after a reset of the product.

15.31.2 Syntax

Command syntax AT+WFM=<mode>[,<FtrID>]

Response syntax +WFM: <FtrID>,<status>,<resetFlag>

| Command | Possible responses |
|--|---|
| AT+WFM=2,"BI9001800" | +WFM: "BI9001800",1,0 OK Dual-band mode 900/1800 is enabled |
| AT+WFM=1,11 Enable the Mono-band 900 mode | OK |
| AT+WFM=0,61 | +CME ERROR: 3 <mode> 0 is not allowed on <FtrID> values with 2 digits |

| | |
|--|--|
| AT+WFM=0,"EFR" Disable the Enhanced Full Rate feature | OK |
| AT+WFM=2 Interrogate all <FtrID> status | +WFM: "MONO900",1,1 +WFM: "MONO1800",0,0 +WFM: "MONO1900",0,0 +WFM: "BI9001800",0,1 +WFM: "BI9001900",0,0 +WFM: "MONO850",0,0 +WFM: "BI8501900",0,0 +WFM: "EFR",0,1 +WFM: "NOHR_NOECHO",0,0 +WFM: "HR",1,0 +WFM: "ECHO",0,0 +WFM: "DTXDATA",1,0 +WFM: "DATA144",1,0 +WFM: "SIM3VONLY",0,0 +WFM: "SIM5VONLY",0,0 +WFM: "SIM3AND5V",1,0 +WFM: "SIMREMOVE",1,0 +WFM: "NOINTERRUPT",0,0 +WFM: "QUICKOFF",0,0 +WFM: "OFFWHENUNPLUG",0,0 +WFM: "INTERRUPT",1,0 +WFM: "SWITCHATT",1,0 +WFM: "CPHS",1,0 +WFM: "SIMSPEEDENH",0,0 +WFM: "LOCA",0,0 OK The modified features have their <resetFlag> parameter set to 1 |

15.31.3 Defined values

<mode>

- 0: disable feature <FtrID>
- 1: enable feature <FtrID>
- 2: interrogate the status of the <FtrID> feature. If the <FtrID> parameter is not used, all features' status are listed with several +WFM responses.

<FtrID>

- 11 or "MONO900": Mono-band mode 900 MHz (def. 0)
- 12 or "MONO1800": Mono-band mode 1800 MHz (def. 0)
- 13 or "MONO1900": Mono-band mode 1900 MHz (def. 0)
- 14 or "BI9001800": Dual-band mode 900/1800 MHz (def. 1)
- 15 or "BI9001900": Dual-band mode 900/1900 MHz (def. 0)
- 16 or "MONO850": Mono-band mode 850 MHz (def. 0)
- 17 or "BI8501900": Dual-band mode 850/1900 MHz (def. 0)
- 2 or "EFR": Enhanced Full Rate feature (def. 1)
- 32 or "HR": Half Rate feature (def. 1)
- 33 or "ECHO": Echo Cancel (def. 0)
- 4 or "DTXDATA": Data with DTX feature (def. 1)

| | |
|------------------------|---|
| 5 or "DATA144": | Data 14.4 kbit/s feature (def. 1) |
| 61 or "SIM3VONLY": | 3V SIM voltage mode (def. 0) |
| 62 or "SIM5VONLY": | 5V SIM voltage mode (def. 0) |
| 63 or "SIM3AND5V": | Both 3 and 5V SIM voltage mode (def. 1) |
| 7 or "SIMREMOVE": | SIM removal feature (def. 1) |
| 81 or "NOINTERRUPT": | No management of interruption (def. 0) |
| 82 or "QUICKOFF": | Quick Off mode (def. 0) |
| 83 or "OFFWHENUNPLUG": | Off when unplug mode (def. 0) |
| 84 or "INTERRUPT": | interruption for customer (def. 1) |
| 9 or "SWITCHATT": | Switch Attenuation feature (def. 1) |
| A or "CPHS": | CPHS feature (def. 1) |
| B or "SIMSPEEDENH" | SIM speed enhancement feature (def.0) |
| C or "LOCA": | Location feature (def. 0) |

Note 1 :

The +WFM response only use alphabetical values for the <FtrID> parameter.

Note 2 :

For <FtrID> values with two digits (like 1x, 6x or 8x), the <mode> 0 value is not allowed. When a « xa » feature is enabled, enabling an other « xb » feature will automatically disable the « xa » feature.

For example, if the "MONO900" feature is enabled, if the "BI9001800" feature is activated, the "MONO900" feature gets automatically disabled.

Likewise, the "HR" feature and the "ECHO" feature are exclusive.

If "NOHR_NOECHO" is activated, both features "HR" and "ECHO" are disabled.

<status>

0: the <FtrID> feature is disabled

1: the <FtrID> feature is enabled

<resetFlag>

0: the feature has not been modified since the last boot of the product.

1: the feature has been modified since the last boot of the product; the product has to be reset in order to take the modification into account.

Note :

If a feature is reset to its initial value after a modification, the <resetFlag> parameter will be reset to 0.

15.32 Commercial Features Management +WCFM

15.32.1 Description

This command allows Wavecom specific features to be enabled or disabled. Disabling a feature can be done with no restriction, but a password is required to enable one (or more) features.

Note :

Once a feature successfully enabled or disabled, the product needs to be reset to take the modification into account.

15.32.2 Syntax

Command syntax AT+WCFM=<mode>,<FtrMask>[,<Password>]

| Command | Possible responses |
|---|---|
| AT+WCFM=? | OK |
| AT+WCFM=0,"0A00" <i>Disable some features</i> | OK |
| AT+WCFM=1,"0003","1234567890A BCDEF1234567890ABCDEF12345678 90ABCDEF1234567890ABCDEF" <i>Enable features</i> | OK <i>The features are enabled (the password is correct)</i> |
| AT+WCFM=1,"0050","1234567890A BCDEF1234567890ABCDEF12345678 90ABCDEF1234567890ABCDEF" <i>Enable features</i> | +CME ERROR: 3 <i>Incorrect password</i> |

15.32.3 Defined values

<mode>

0: disable some features of <FtrMask>

1: enable some features of <FtrMask>

<FtrMask> 16 bits hexadecimal string (4 characters from 0 to F)

<PassWord> 256 bits hexadecimal string (64 characters from 0 to F)

15.33 Wavecom Customer storage mirror +WMIR

15.33.1 Description

This **specific** command allows to make a mirror copy of the current configuration parameters. In case of memory problem for the storage, if a customer mirror already exists, this one will be restored. Otherwise, the Wavecom default mirrored parameters are restored.

15.33.2 Syntax

Command syntax AT+WMIR

| Command | Possible responses |
|---|--------------------|
| AT+WMIR=? | OK |
| AT+WMIR <i>Build the Customer Mirror</i> | OK |

15.34 Wavecom Change Default Player +WCDP

15.34.1 Description

This **specific** command allows the default melody player to be selected.

15.34.2 Syntax

Command syntax AT+WCDP = <player>

| Command | Possible responses |
|---|---------------------|
| AT+WCDP=? | +WCDP : (0-1) OK |
| AT+WCDP=0 <i>Select the speaker.</i> | OK |
| AT+WCDP? | +WCDP: 0 OK |

15.34.3 Defined values :

<player>

0: Buzzer
1: Speaker

15.35 Wavecom CPHS Mail Box Number +WMBN

15.35.1 Description

This **specific** command allows to set the different mailbox numbers in SIM. The +CPHS command can be used to know which mailbox numbers can be updated.

15.35.2 Syntax

Command syntax AT+WMBN = <Lineld>,<number>,<type>

Response syntax (AT+CPHS=2,2)

+WMBN = <Lineld>,<number>,<type>,<status>

| Command | Possible responses |
|---|--|
| AT+WMBN=? | OK |
| AT+WMBN? | OK |
| AT+CPHS=2,2 <i>Get the current Mail Box Numbers in SIM</i> | +WMBN: 1,"0123456789",129,1 +WMBN: 2,"9876543210",129,1 +WMBN: 3,,0 +WMBN: 4,,0 OK |
| AT+WMBN=1,"+33122334455",145 <i>Set mailbox number for line1.</i> | OK <i>Mailbox number for Line1 is set.</i> |
| AT+WMBN=2,"0166778899",129 <i>Set mailbox number for line2.</i> | OK <i>Mailbox number for Line2 is set.</i> |
| AT+WMBN=3,"0102030405",129 <i>Set mailbox number for FAX Line.</i> | +CME ERROR: 21 <i>Invalid index: Fax Line mailbox number can not be updated with this SIM card.</i> |
| AT+CPHS=2,2 <i>Get the current Mail Box Numbers again</i> | +WMBN: 1,"+ 33122334455",145,1 +WMBN: 2,"0166778899",129,1 +WMBN: 3,,0 +WMBN: 4,,0 OK |

15.35.3 Defined values :

<Lineld>

- 1: Line 1
- 2: Line 2
- 3: FAX
- 4: DATA

<number> Phone number in ASCII format.

<type> TON/NPI (Type of address octet in integer format).

<status> When checked with "AT+CPHS=2,2", it indicates if the number can be updated or not:

- 0: Update is not possible
- 1: Update is possible

15.36 Wavecom Open AT control command +WOPEN

15.36.1 Description

This **specific** command allows to start, stop and get information about the current Open AT embedded application.

Note :

This command is only available if the Open AT feature is enabled (cf +WCFM command).

15.36.2 Syntax

Command syntax AT+WOPEN=<Mode>

Response syntax +WOPEN: <Mode>[,<IntVersion>[<ExtVersion>]]

| Command | Possible responses |
|--|---|
| AT+WOPEN=? | +WOPEN: (0-2) OK |
| AT+WOPEN? | +WOPEN: 0 OK |
| AT+WOPEN=2 <i>Get the Open-AT library versions.</i> | +WOPEN: 2, "AT v1.00", "AT v1.00" OK <i>Open-AT v1.00 library version. An embedded application has been downloaded on this product.</i> |
| AT+WOPEN=3 | OK The objects flash are erased |
| AT+WOPEN=1 <i>Start the embedded application.</i> | OK +WIND: 3 <i>Product reset in order to start the embedded application.</i> |
| AT+WOPEN = 3 | +CME ERROR: 532 the embedded application is activated so the objects flash are not erased. |
| AT+WOPEN=0 <i>Stop the embedded application.</i> | OK +WIND: 3 <i>Product reset in order to stop the embedded application.</i> |
| AT+WOPEN=3 | OK The objects flash are erased |
| AT+WOPEN? | +CME ERROR: 3 <i>The Open AT feature is disabled.</i> |

15.36.3 Defined values :

<Mode>

- 0: Stop the embedded application. If this one was running, the product resets.
- 1: Start the embedded application. If this one was stopped, the product resets.
- 2: Get the Open AT library versions.
- 3: Erase the objects flash of Open-AT embedded application.

Note : (Mode = 3) is only available if Open-AT embedded application is stopped (AT+WOPEN=0).

<IntVersion> Ascii string giving the internal Open AT library version.

<ExtVersion> Ascii string giving the external Open AT library version.

Note :

If no embedded application is loaded, the <ExtVersion> parameter does not appear.

15.37 Wavecom Reset +WRST

15.37.1 Description

This specific command allows to reset the module after the time specified by the second parameter.

15.37.2 Syntax

Command syntax : AT+WRST = <Mode>,<Delay>

Response syntax : +WRST: <Mode>,<Delay>,<RemainTime>

| Command | Possible responses |
|---|---|
| AT+WRST=? | OK |
| AT+WRST=0 <i>Disable timer</i> | OK |
| AT+WRST=1,"001:03" <i>Enable timer and put delay at 1 hour 3 minutes</i> | OK |
| AT+WRST? | +WRST: 1,"001:03","001:01" OK <i>Note: Timer activated to reset after 1 hour and 3 minutes. Actually 1 hour and 1 minute remaining before next reset.</i> |

15.37.3 Defined values :

| | |
|--------------|---|
| <val1> | 0: timer reset is disabled 1: timer reset is enabled |
| <Delay> | specifie the time for reset "000:00"- "168:59" |
| <RemainTime> | time before next reset "000:00"- "168:59" |

15.38 Set Standard Tone +WSST

15.38.1 Description :

This specific command allows to set/get the sound level of the Standard Tones.

15.38.2 Syntax :

Command syntax : AT+WSST=[<sound level>][,<ring tone level>]

| Command | Possible responses |
|--|---|
| AT+WSST=0 <i>Note : Set volume to Max.</i> | OK |
| AT+WSST=15 <i>Note : Set volume to Min.</i> | OK |
| AT+WSST=,5 <i>Note : Set ring tone level to 5</i> | OK |
| AT+WSST? <i>Note : get current standard tones sound level</i> | +WSST: 15,5 OK <i>Note : current standard tones level is 15 (min.), and ring tone level is 5.</i> |
| AT+WSST=? <i>Note : supported parameters</i> | +WSST: (0-15),(0-15) OK |

15.38.3 Defined values :

<sound level> 0 Max volume (default)

 15 Min volume

 <ring tone level> 0 Max volume (default)

 15 Min volume

15.39 Wavecom Location +WLOC

15.39.1 Description :

This specific command can be used by the application to retrieve the local information: MCC-MNC,LAC,CI,Network measurement,BCCH channel list, Timing Advance, Date and Time.

Two ways may exist for the external application to know these information : on request of the application, or automatically by the module every x seconds (x has to be a multiple of 5 different from 0).

The location feature has to be activated to get information.

if the feature is not activated, "ERROR" is sent.

If the data are not valid at the requested time, the network measurement, BCCH list and Timing Advance cannot be displayed (",,," is displayed).

15.39.2 Syntax :

Command syntax : AT+WLOC =< mode > [, < time period/dump >]

| Command | Possible responses |
|--|---|
| AT+WLOC=0 <i>Note : stops the display of local information</i> | OK |
| AT+WLOC=3,255 <i>Note : set the wished information to display (255 -> complete information)</i> | OK |
| AT+WLOC=1 <i>Note : displays once the local information</i> | +WLOC: 02f802,0006,7772,f13101b04cf51278 91138e95a846d160,8b49d08d0797c419e2 72e10889a000009302170399020403c1020 a03c5020a03,00,010121111349ff OK |
| AT+WLOC=2,6 <i>Note : 6 is not a multiple of 5</i> | +CME ERROR:3 |
| AT+WLOC=2,10 <i>Note : displays OK then the current local information immediately for the first time and then every 10 seconds.</i> | OK +WLOC: 02f802,0006,7772,ed3001af4cf492780 b040889c74acc23,8b49d08d0797c419e272e1 0889a000009302160399020503c1020a03c5020 a03,00,010121111354ff +WLOC: 02f802,0006,7772,f02d01ae4cf41278 4b03c889c846dba5,8b49d08d0797c419e27 2e10889a000009302170399020403c1020a0 3c5020903,00,010121111404ff ... |
| Command | Possible responses |
| AT+WLOC=? <i>The feature "loca" is not activated</i> | +CME ERROR:3 |
| AT+WLOC? | +CME ERROR:3 |

| | |
|---|----------------------|
| <i>The feature "loca" is not activated</i> | |
| AT+WLOC=? <i>The feature "loca" is activated</i> | OK |
| AT+WLOC? <i>The location is not in mode automatic</i> <i>The period value is set to 5 seconds</i> <i>The configuration value is set to 255</i> | +WLOC: 0,5,255 OK |
| AT+WLOC? <i>The location is in mode automatic</i> <i>The period value is set to 10 seconds</i> <i>The configuration value is set to 20</i> | +WLOC: 1,10,20 OK |

15.39.3 Defined values :

<mode>

- 0 : Stop automatic shots
- 1 : One shot requested
- 2 : Automatic shots requested (every x seconds)
- 3 : Configuration of the wished information

for mode == 2 : <time period> optional parameter – range: 5-255 – in seconds
it has to be a multiple of 5.
default value of time period: 5 seconds

note:

if no time period is given with the command "at+wloc=2", 5 seconds will be choosen.

The automatic mode for location is saved in EEPROM, so will be taken into account after an Init (+WLOC:... will be displayed).

for mode == 3 : <dump> optional parameter – range: 1-255 (at least 1 bit set to 1).

if bit 0 set to 1: DaT will be given in the response

if bit 1 set to 1: TA will be given in the response

if bit 2 set to 1: BCCH will be given in the response

if bit 3 set to 1: NetMeas will be given in the response

if bit 4 set to 1: CI will be given in the response

if bit 5 set to 1: LAC will be given in the response

if bit 6 set to 1: MNC-MCC will be given in the response

After having downloaded the EEPROM configuration: default value of dump =0xFF (all information given).

The <dump> value set with the command "at+wloc=3,xx" is saved in EEPROM, so will be taken into account after an Init.

15.39.4 Fields of the response of at+wloc=1 or at+wloc=2 :

The format of these fields are as specified in 04.08

| | |
|----------------------|---|
| MCC-MNC: | 3 bytes |
| LAC: | 2 bytes |
| CI: | 2 bytes |
| Network measurement: | 16 bytes (chapter 10.5.2.20) |
| BCCH channel list: | maximum 48 bytes(version V0) Or 129 bytes (version V1) |
| Timing Advance: | 1 byte |
| Date and Time: | 7 bytes: Date, time and timezone at STLK Format |

15.39.5 Fields of the response of at+wloc? :

+wloc: mode, time period, dump
mode : 0: no automatic mode
 1: automatic mode
period, dump: see 15.39.3

15.40 Wavecom Bus Read +WBR

15.40.1 Description

This **specific** command allows to read a buffer from a specific bus (SPI or I2C Soft).

Note : Bus configuration is set by the **+WBM** command.

15.40.2 Syntax

Command syntax: AT+WBR=<BusId>,<Size>[,<Address>[,<Opcode>]]

Response syntax: +WBR:
 <Data>
 OK

| Command | Possible responses |
|---|--------------------------------|
| AT+WBR=0,9,1,"08C9" <i>Read 9 bytes from the SPI bus, using SPI_EN chip select, after have sending the 0xC9 Opcode byte.</i> | +WBR: 0A5F98231012345678 OK |
| AT+WBR=1,5,"2A" <i>Read 5 bytes from the I2C Soft bus, at the 0x2A slave address.</i> | +WBR: 0102030405 OK |

15.40.3 Defined values

< BusId >

0: SPI bus.

1: I2C Soft bus.

<Size>

Size of data to read (max 256 bytes).

<Address>

For SPI bus :

Chip select to use to read data from the SPI bus.

0: No Chip Select. The application should use a GPIO as a Chip Select.

1: SPI_EN Chip Select.

2: SPI_AUX Chip Select.

For I2C Soft bus :

Slave address byte, in hexadecimal characters (default "00").

This is a 7-bits address, shifted to left from 1 bit, padded with the LSB set to 1 (to read), and sent first on the I2C bus before performing the reading operation.

Note : this parameter is required for SPI bus, and optional for I2C Soft bus.

<Opcode> (for SPI bus only, default "0000")

2 bytes hexadecimal string, used to send an operation code byte on the SPI bus, before performing the reading operation. The first byte is the operation code length, in bits (from 1 to 8). The second byte is the operation code value.

Note : as the MSB is always sent first, if the length is less than 8 bits, only the most significant bytes will be sent (example : to send first a bit set to 1, the opcode parameter must be set to "0180").

15.41 Wavecom Bus Write +WBW

15.41.1 Description

This **specific** command allows to write a buffer on a specific bus (SPI or I2C).

Note : Bus configuration is set by the +WBM command.

15.41.2 Syntax

Command syntax: AT+WBW=<BusId>,<Size>[,<Address>]<CR>
> <Data Buffer> <ctrl-Z >

| Command | Possible responses |
|--|--|
| AT+WBW=0,10,1<CR> 0123456789ABCDEF0123<ctrl-Z> <i>Write 10 bytes on the SPI bus, using the SPI EN chip select.</i> | OK <i>Data buffer is written on SPI bus.</i> |
| AT+WBW=1,5<CR> 0246801234<ctrl-Z> <i>Write 5 bytes on the I2C Soft bus.</i> | OK <i>Data buffer is written on I2C Soft bus.</i> |

15.41.3 Defined values

<BusId>

- 0: SPI bus.
- 1: I2C Soft bus.

<Size>

Size of data buffer, in bytes. (max. 256 bytes)

<Address>

For SPI bus :

Chip select to use to write data on the SPI bus.

- 0: No Chip Select. The application should use a GPIO as a Chip Select.
- 1: SPI_EN Chip Select.
- 2: SPI_AUX Chip Select.

For I2C Soft bus :

Slave address byte, in hexadecimal characters (**default "00"**).

This is a 7-bits address, shifted to left from 1 bit, padded with the LSB set to 0 (to write), and sent first on the I2C bus before performing the writing operation.

Note : this parameter is required for SPI bus, and optional for I2C Soft bus.

<Data Buffer>

Data buffer to write on the specific bus. This parameter must only contain hexadecimal characters (0-9, A-F), and must be long as twice the <Size> parameter.

15.42 Wavecom Bus Management +WBM

15.42.1 Description

This **specific** command allows to manage specific buses (SPI or I2C Soft) with a given configuration.

15.42.2 Syntax

Command Syntax AT+WBM=<BusId>,<Mode>
 [,<Clk Speed / SCL Gpio> [],<Clk Mode / SDA Gpio>]]

| Command | Possible responses |
|---|-------------------------|
| AT+WBM=0,1,1,3 <i>Open SPI bus with configuration :</i> <i>Clock Speed : 812 kHz</i> <i>Clock Mode : 3</i> | OK |
| AT+WBM=1,1,0,4 <i>Open I2C Soft bus with configuration :</i> <i>Scl Gpio : 0</i> <i>Sda Gpio : 4</i> | OK |
| AT+WBM=0,2 | +WBM: 0,1,1,3 OK |
| AT+WBM=1,0 <i>Close I2C bus.</i> | OK |
| AT+WBM=1,2 | +WBM: 0,0,0,4 OK |
| AT+WBM=1,1 <i>Open I2C Soft bus with the last configuration :</i> <i>Scl Gpio : 0</i> <i>Sda Gpio : 4</i> | OK |
| AT+WBM = 1,2 | +WBM: 1,1,0,4 OK |

15.42.3 Defined values

<BusId>

0 : SPI bus.

1 : I2C bus.

<Mode>

0 : close bus.

1 : open bus.

2 : get bus status.

<Clk Speed / SCL Gpio>

 confidential ©

Page : 176 / 281

This document is the sole and exclusive property of WAVECOM. Not to be distributed or divulged without prior written agreement. Ce document est la propriété exclusive de WAVECOM. Il ne peut être communiqué ou divulgué à des tiers sans son autorisation préalable.

for SPI bus : Clock Speed (default 0)

- 0 : 101Khz.
- 1 : 812Khz.
- 2 : 1625Mhz.
- 3 : 325Mhz.

for I2C bus : Scl Gpio (default 0)

The Scl Gpio value is between **0** and **7**.
It must be a Gpio (not Gpi or Gpo) and not allocated by an Open-AT embedded application.

<Clk Mode / SDA Gpio>**for SPI bus : Clock Mode (default 0)**

- 0 : the rest state is 0, the data is valid on rising edge.
- 1 : the rest state is 0, the data is valid on falling edge.
- 2 : the rest state is 1, the data is valid on rising edge.
- 3 : the rest state is 1, the data is valid on falling edge.

for I2C Soft bus : Sda Gpio (default 4)

The Sda Gpio value is between **0** and **7**.
It must be a Gpio (not Gpi or Gpo) and not allocated by an Open-AT embedded application.

Notes :

- If the I2C soft bus is opened, the two used GPIO are not available for the +WIOR , +WLOW, +WIOM commands. When the I2C bus is closed, these commands resume the control of the two GPIO.
- A bus may not be available to open operation if an Open-AT embedded application has opened it before. In this case, the +WBM command will return +CME ERROR: 3.

15.43 Wavecom Hang-up +WATH

15.43.1 Description

This **specific** command is used by the application to disconnect the remote user, specifying a release cause and the location. In the case of multiple calls, all calls are released (active, on-hold and waiting calls).

15.43.2 Syntax

Command Syntax AT+WATH=<RelCause>,<location>

| Command | Possible responses |
|--|--|
| AT+WATH=31 <i>Note : Ask for disconnection with release cause=normal and location=USER</i> | OK <i>Note : Every call, if any, are released</i> |
| AT+WATH=? | +WATH: (1-127) , (0-5,7,10) |
| AT+WATH=17,2 <i>Note : Ask for disconnection with release cause=user busy and location= public network serving the local user</i> | OK <i>Note : Every call, if any, are released</i> |

15.43.3 Defined values

<RelCause> :

decimal value from 1 to 127

see the table in appendices 18.4 "Failure Cause from GSM 04.08 recommendation"

<location> :

optional parameter (default value =0)

values as defined in 04.08

- 0 : user
- 1 : private network serving the local user
- 2 : public network serving the local user
- 3 : transit network
- 4 : public network serving the remote user
- 5 : private network serving the remote user
- 7 : international network
- 10 : network beyond interworking point

Notes :

"AT+WATH=0" is the same as "ath"

15.44 Write IMEI +WIMEI

15.44.1 Description

The download of the IMEI is available through this **specific** command. This operation is possible only if the module contains the default IMEI.

The IMEI can only be downloaded once.

No password is needed. If the download is not correct, only Wavecom can reset the IMEI.

15.44.2 Syntax

Command syntax AT+WIMEI=<IMEI>

| Command | Possible responses |
|--|--|
| AT+WIMEI? <i>Request IMEI</i> | +WIMEI: 123456789012345 OK <i>Note: Default IMEI present in EEPROM</i> |
| AT+WIMEI=123456789099995 First Download | OK |
| AT+WIMEI=12345 <i>First Download with wrong length of the string</i> | +CME ERROR: 24 |
| AT+WIMEI=123456789999996 <i>Try to overwrite an IMEI already downloaded</i> | +CME ERROR: 3 |
| AT+WIMEI? <i>Request IMEI</i> | +WIMEI: 123456789099995 OK <i>Note: IMEI present in EEPROM</i> |
| AT+WIMEI=? | OK <i>Note: Command valid</i> |

15.44.3 Defined values

<IMEI>

14 or 15 digits as defined by GSM 03.03.

16 SIM TOOLKIT

16.1 Overview of SIM Application ToolKit

16.1.1 Summary

SIM ToolKit, also known as "SIM Application ToolKit" introduces new functionalities, which open the way to a broad range of value added services. The principle is to allow service providers to develop new applications (*e.g.* for banking, travel, ticket booking, etc.) for subscribers and to download them into the SIM.

This solution allows new services to be accessible to the user by adding new SIM-based applications without modifying the handset.

16.1.2 Functionality

SIM Toolkit refers to the functionalities described in the GSM Technical specification 11.14.

It introduces about twenty five new commands for the SIM. Three classes of ToolKit functionalities have been defined, with class 1 offering a subset of commands and class 3 offering the full range of commands (*See table 1 in APPENDIX B*).

The SIM Application Toolkit supports:

- ☞ profile download,
- ☞ proactive SIM,
- ☞ data download into SIM.
- ☞ menu selection,
- ☞ call control by SIM.

16.1.3 Profile download

The Profile Download instruction is sent by the customer application to the SIM as part of the initialization. It is used to indicate which SIM Application Toolkit features the customer application supports.

The AT command used for this operation is **+STSF** (*SIM ToolKit Set Facilities*).

16.1.4 Proactive SIM

A proactive SIM provides a mechanism whereby the SIM can ask the customer application to perform certain actions.

These actions include:

- display menu,
- display given text,
- get user input,
- send a short message,
- play the requested tone,
- set up a call,
- provide location information.

This mechanism allows SIM applications to generate powerful menu-driven sequences on the customer application and to use services available in the network.

The commands used for this operation are:

+STIN (*SIM Toolkit Indication*),
+STGI (*SIM Toolkit Get Information*),
+STGR (*SIM Toolkit Give Response*).

16.1.5 Data Download to SIM

Data downloading to the SIM allows (*SMS, phonebook...*) data or programs (*Java applets*) received by SMS or by Cell Broadcast to be transferred directly to the SIM Application.

This feature does not need any AT command. It is transparent to the customer application.

16.1.6 Menu Selection

A set of menu items is supplied by the SIM Application ToolKit. The menu selection command can then be used to inform the SIM Application which menu item is selected.

The commands used for this operation are **+STIN**, **+STGI** and **+STGR**.

16.1.7 Call control by SIM

The call control mechanism allows the SIM to check all dialed numbers, supplementary service control strings and USSD strings before connecting to the network. This gives the SIM the ability to allow, bar or modify the string before the operation starts.

The commands used for this operation are :

+STCR (*SIM Toolkit Control Response*),
+STGR (*SIM Toolkit Give Response*).

16.2 Messages exchanged during a SIM ToolKit operation.

The following scheme shows the SIM Toolkit commands and unsolicited results that are exchanged.

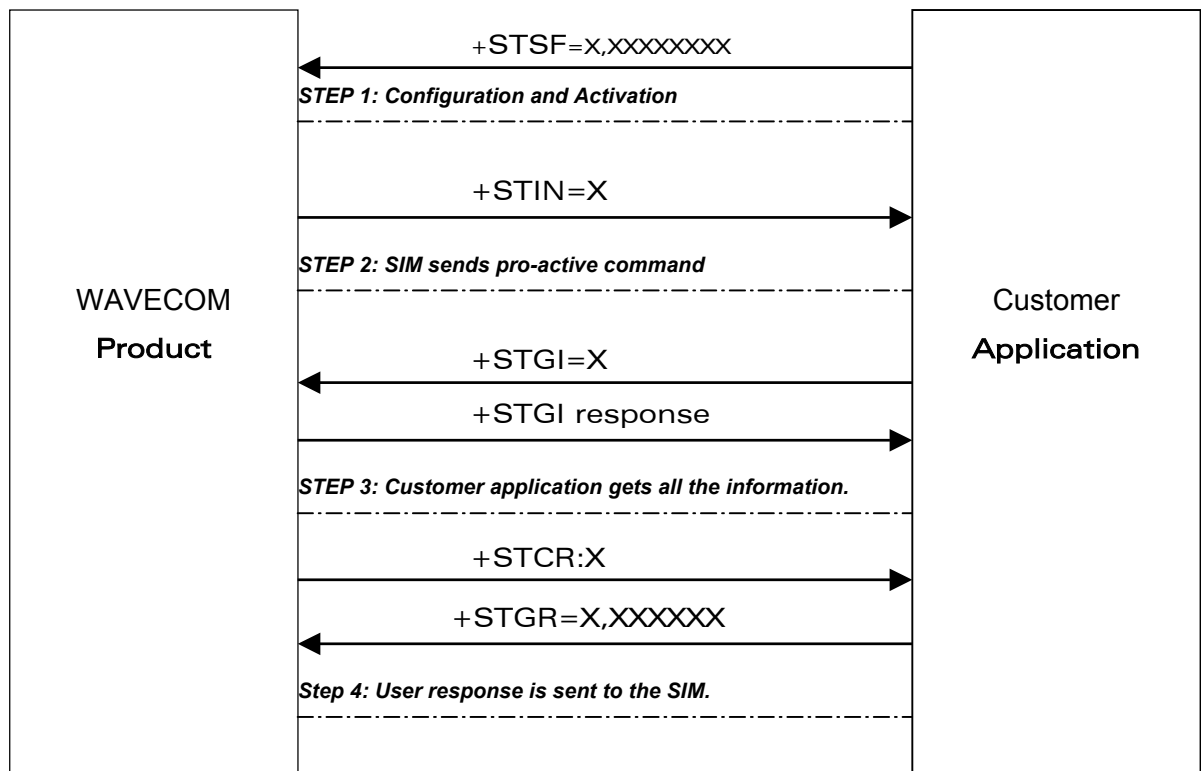

On the first step the customer application informs the WAVECOM product which facilities are supported. This operation is performed with the **+STSF** (*SIM Toolkit Set Facilities*) command, which also allows to activate or deactivate the SIM Toolkit functionality.

On the second step an unsolicited result **+STIN** (*SIM Toolkit indication*) is sent by the product, in order to indicate the customer application which command type the SIM Application Toolkit is running on the SIM card. The last SIM Toolkit indication can be requested by the **+STIN?** command.

On the third step the customer application uses the **+STGI** (*SIM Toolkit Get Information*) command to get all the information about the SIM Toolkit command, given by **+STIN**.

On the fourth step the customer application uses the **+STGR** (*SIM Toolkit Give Response*) to send its response (*if any*) to the SIM Toolkit Application.

The **+STCR** (*SIM Toolkit Control response*) indication is an unsolicited result sent by the SIM when Call control functionality is activated and before the customer application has performed any outgoing call, SMS, SS, or USSD.

16.3 SIM TOOLKIT COMMANDS

16.3.1 SIM ToolKit Set Facilities (+STSF)

16.3.1.1 Description

This command allows SIM ToolKit facilities to be activated, deactivated or configured.

16.3.1.2 Syntax

Command syntax :

+STSF=<mode>[,<config>][,<Timeout>][,<AutoResponse>]

| Command | Possible responses |
|--|---|
| +STSF=<Mode>[,<Config>][,<Timeout>][,<AutoResponse>] | OK +CME ERROR: <err> |
| +STSF? | +STSF: <Mode>,<Config>,<Timeout>,<Autoresponse> |
| +STSF=? | +STSF: (0-2), (160060C01F - 5FFFFFFF7F),(1-255),(0-1) OK |

16.3.1.3 Defined values

<mode>

- 0: Deactivates the SIM Toolkit functionalities.
- 1: Activates the SIM Toolkit functionalities.
- 2: Configures the SIM Toolkit functionalities.

<Config>

(160060C01F - 5FFFFFFF7F) *(hex format)*

<Timeout>

1-255: Timeout for user responses (multiple of 10 seconds).

<Autoresponse>

- 0: Automatic response is not activated
- 1: Automatic response is activated

The activation or deactivation of the SIM Toolkit functionalities requires the use of the +CFUN (*Set phone functionality*) command to reset the product (this operation is not necessary if PIN is not entered yet).

The <Config> parameter gives the coding of the TERMINAL PROFILE, precisely the list of SIM Application Toolkit facilities that are supported by the customer application.

The <Timeout> parameter (multiple of 10 seconds) sets the maximum time the user has for reacting (to select an item, to input a text, etc).

When the <Autoresponse> is activated, the +STIN indication for Play Tone (5), Refresh (7), Send SS (8), Send SMS (9) or Send USSD (10) is automatically followed by the corresponding +STGI response.

Note:

Some bits are related to the product only and not to the customer application. The product automatically sets these bits to either 0 or 1 whatever the user enters with the +STSF command. Those values are given in Appendix C.

Each facility is coded on 1 bit:

- bit = 1: facility is supported by the customer application.
- bit = 0: facility is not supported by the customer application.

Only the first five bytes of the TERMINAL PROFILE (Class 2) can be configured, the other are set to 0. (See structure of TERMINAL PROFILE in APPENDIX C)

16.3.1.4 Error codes

+CME ERROR: 3 **Operation not allowed.** This error is returned when a wrong parameter is entered.

16.3.1.5 Example

```
AT+CME=1                    Enable the reporting of mobile equipment errors
OK
AT+WIND=15                 Set Wavecom indications
OK
AT+CPAS                    Query ME Status
+CPAS: 0                   ME is ready.
OK
AT+STSF=?                 Test command SIM ToolKit Set Facilities
+STSF: (0-2), (160060C01F - 5FFFFFFF7F),(1-255)
OK
AT+STSF?                   No activation of SIM ToolKit functionality
+STSF: 0,"160060C000",3
OK
AT+STSF=2,"5FFFFFFF7F"   Set all SIM ToolKit facilities (class 3).
OK
AT+STSF=3                 Syntax Error
+CME ERROR: 3
AT+STSF=1                 Activation of SIM ToolKit functionality
OK
AT+CFUN=1                 Reboot Software.
OK
AT+CPIN?                   Is the ME requiring a password?
+CPIN: SIM PIN            Yes, SIM PIN required
AT+CPIN=0000
OK     PIN OK
+WIND: 4                   Init phase is complete
AT+STSF?
+STSF: 1,"5FFFFFFF7F",3   SIM ToolKit functionality activated with all facilities
OK
```

16.3.2 SIM ToolKit Indication (+STIN)

16.3.2.1 Unsolicited result

In order to allow the customer application to identify the pro-active command sent via SIM ToolKit, a mechanism of unsolicited SIM ToolKit indications (**+STIN**) is implemented.

Syntax : +STIN: <CmdType>

Option : <CmdType>

- 0:** Indicates that a 'Setup Menu' pro-active command has been sent from the SIM.
- 1:** Indicates that a 'Display Text' pro-active command has been sent from the SIM.
- 2:** Indicates that a 'Get Inkey' pro-active command has been sent from the SIM.
- 3:** Indicates that a 'Get Input' pro-active command has been sent from the SIM.
- 4:** Indicates that a 'Setup Call' pro-active command has been sent from the SIM.
- 5:** Indicates that a 'Play Tone' pro-active command has been sent from the SIM. (*)
- 6:** Indicates that a 'Sel Item' pro-active command has been sent from the SIM.
- 7:** Indicates that a 'Refresh' pro-active command has been sent from the SIM. (*)
- 8:** Indicates that a 'Send SS' pro-active command has been sent from the SIM. (*)
- 9:** Indicates that a 'Send SMS' pro-active command has been sent from the SIM. (*)
- 10:** Indicates that a 'Send USSD' pro-active command has been sent from the SIM. (*)
- 11:** Indicates that a 'SETUP EVENT LIST' pro-active command has been sent from the SIM.
- 98:** Indicates the timeout when no response from user.
- 99:** Indicates that a "**End Session**" has been sent from the SIM.

(*) if the automatic response parameter is activated, this indication is followed by the corresponding +STGI response.

16.3.2.2 Last SIM toolkit indication

The last SIM toolkit indication sent by the SIM can be requested by the **AT+STIN?** command. This command is only usable between the sending of the STIN indication by the SIM (step 2 : see section 16.2) and the response of the user with the +STGI command (step 3).

Command syntax : +STIN?

| Command | Possible responses |
|---|---|
| +STIN? <i>Note : Ask for the last SIM toolkit indication sent by the SIM</i> | +STIN: 0 OK <i>Note : the last SIM toolkit indication was a Setup Menu</i> |
| +STGI=0 | <i>Note : Display the SIM toolkit application menu</i> |
| +STIN? <i>Note : Ask for the last SIM toolkit indication sent by the SIM</i> | +CME ERROR: 4 <i>Note : operation not supported, the +STGI command has been already used</i> |

16.3.3 SIM ToolKit Get Information (+STGI)

16.3.3.1 Description

This command allows to get the information (*text to display, Menu information, priorities...*) of a pro-active command sent from the SIM. The information is returned only after receiving a SIM Toolkit indication (*+STIN*).

16.3.3.2 Syntax

Command syntax : +STGI=<CmdType>

| Command | Possible responses |
|-----------------|----------------------------------|
| +STGI=<CmdType> | See Table 1 +CME ERROR: <err> |
| +STGI=? | +STGI: (0-11) OK |

Table 1

| Cmd Type | Description | Possible responses |
|----------|--|---|
| 0 | Get information about 'Setup Menu' pro-active command. | +STGI: <Alpha Identifier menu> +STGI: <Id1>,<NbItems>,<Alpha Info>[,<NextActionId>]<CR><LF> +STGI: <Id2>,<NbItems>,<Alpha Info>[,<NextActionId>]<CR><LF> [...] No action expected from SIM. |
| 1 | Get information about 'Display text' pro-active command. | +STGI: <Prior>,<Text>,<ClearMode> No action expected from SIM. |
| 2 | Get information about 'Get Inkey' pro-active command. | +STGI: <Format>,<HelpInfo>[,<TextInfo>] SIM expects key pressed (+STGR). |
| 3 | Get information about 'Get Input' pro-active command. | +STGI: <Format>,<EchoMode>,<SizeMin>,<SizeMax>,<HelpInfo>[,<TextInfo>] SIM expects key input (+STGR). |
| 4 | Get information about 'Setupt call' pro-active command. | +STGI: <Type>,<CalledNb>,<SubAddress>,<Class> SIM expects user authorization (+STGR). |
| 5 | Get information about 'Play Tone' pro-active command. | +STGI: <ToneType>[,<TimeUnit>,<TimeInterval>,<TextInfo>] No action. |
| 6 | Get information about 'Sel Item' pro-active command. | +STGI: <DefaultItem>,<Alpha Identifier menu><CR><LF> +STGI: <Id1>,<NbItems>,<Alpha Info>[,<NextActionId>]<CR><LF> +STGI: <Id2>,<NbItems>,<Alpha Info>[,<NextActionId>]<CR><LF> [...] SIM expects an item choice (+STGR). |
| 7 | Get information about 'Refresh' pro-active command. | +STGI: <RefreshType> No action (Refresh done automatically by product). |
| 8 | Get information about 'Send SS' pro-active command. | +STGI:<TextInfo> No action (Send SS done automatically by product). |
| 9 | Get information about 'Send SMS' pro-active command. | +STGI: <TextInfo> No action (Send SMS done automatically by product). |

| | | |
|----|--|--|
| 10 | Get information about 'Send USSD' pro-active command. | +STGI: <TextInfo> No action (Send USSD done automatically by product). |
| 11 | Get information about 'SETUP EVENT LIST' pro-active command. | +STGI: <Evt> |

16.3.3.3 Defined values

Values when CmdType=0 (Setup menu)

| | |
|-------------------------|---|
| <Alpha Identifier menu> | Alpha identifier of the main menu. |
| <Idx> (1-255) | Menu item Identifier. |
| <NbItems> (1-255) | Number of items in the main menu. |
| <Alpha Idx Label> | Alpha identifier label of items in ASCII format. |
| <HelpInfo> | |
| 0: | No help information available. |
| 1: | Help information available. |
| <NextActionId> | Contains a pro-active command identifier. (see the table in APPENDIX D) |

Compared to other commands the customer application can always get information about setup menu after having received the +STIN:0 indication.

Values when CmdType=1 (Display text)

| | |
|-------------|---|
| <Prior> | |
| 0: | Normal priority of display. |
| 1: | High priority of display. |
| <Text> | Text to display in ASCII format. |
| <ClearMode> | |
| 0: | Clear message after a delay (3 seconds) |
| 1: | Wait for user to clear message. |

Values when CmdType=2 (Get Inkey)

| | |
|------------|-----------------------------------|
| <Format> | |
| 0: | Digit (0-9, *, #, and +) |
| 1: | SMS alphabet default. |
| 2: | UCS2 |
| <HelpInfo> | |
| 0: | No help information available. |
| 1: | Help information available. |
| <TextInfo> | Text information in ASCII format. |

Values when CmdType=3 (Get Input)

| | |
|----------|--------------------------|
| <Format> | |
| 0: | Digit (0-9, *, #, and +) |
| 1: | SMS alphabet default. |
| 2: | UCS2 |
| 3: | Unpacked format. |
| 4: | Packed format. |

| | |
|--------------------------------|-----------------------------------|
| <EchoMode> | |
| 0: | Echo off. |
| 1: | Echo on. |
| <SizeMin> (1-255) | Minimum length of input. |
| <SizeMax> (1-255) | Maximum length of input. |
| <HelpInfo> | |
| 0: | No help information available. |
| 1: | Help information available. |
| <TextInfo> | Text information in ASCII format. |

Values when CmdType=4 (Setup Call)

| | |
|--------------------------|---|
| <Type> | |
| 0: | Set up call but only if not currently busy on another call. |
| 1: | Set up call, putting all other calls <i>(if any)</i> on hold. |
| 2: | Set up call, disconnecting all other calls <i>(if any)</i> . |
| <CalledNb> | Called party number in ASCII format. |
| <SubAdress> | Called party sub-address in ASCII format. |
| <Class> | |
| 0: | Voice call. |
| 1: | Data call. |
| 2: | Fax call |

Values when CmdType=5 (Play tone)

| | |
|-------------------------------------|--------------------------------------|
| <ToneType> | |
| 0: | Tone Dial. |
| 1: | Tone Busy. |
| 2: | Tone Congestion. |
| 3: | Tone Radio ack |
| 4: | Tone Dropped. |
| 5: | Tone Error. |
| 6: | Tone Call waiting. |
| 7: | Tone Ringing. |
| 8: | Tone General beep. |
| 9: | Tone Positive beep. |
| 10: | Tone Negative beep. |
| <TimeUnit> | |
| 0: | Time unit used is minutes. |
| 1: | Time unit used is seconds. |
| 2: | Time unit used is tenths of seconds. |
| <TimeInterval> (1-255) | Time required expressed in units. |
| <TextInfo> | Text information in ASCII format. |

Values when CmdType=6 (Sel Item)

| | |
|--------------------------------------|--|
| <DefaultItem> (1-255) | Default Item Identifier. |
| <Alpha Identifier menu> | Alpha identifier of the main menu. |
| <Idx> (1-255) | Identifier items. |
| <NbItems> (1-255) | Number of items in the menu. |
| <Alpha Idx Label> | Alpha identifier label of items in ASCII format. |

<HelpInfo>

- 0:** No help information available.
1: Help information available.
<NextActionId> Contains a pro-active command identifier. (*see the table in APPENDIX D*)

Values when CmdType=7 (Refresh)**<RefreshType>**

- 0:** SIM initialization and full file change notification.
1 File change notification.
2 SIM initialization and file change notification.
3 SIM initialization.
4 SIM reset.

Values when CmdType=8 (Send SS)

<TextInfo> Text information in ASCII format.

Values when CmdType=9 (Send SMS)

<TextInfo> Text information in ASCII format.

Values when CmdType=10 (Send USSD)

<TextInfo> Text information in ASCII format.

Values when CmdType=11 (Setup Event List)**<Evt>**

- 1:** Reporting asked for an 'Idle Screen' event.
2: Reporting asked for an 'User Activity' event.
3: Reporting asked for 'Idle Screen' and 'User Activity' events.
4: Cancellation of reporting event.

Rem : For the UCS2 format texts are displayed in Hexa Ascii format. Example : When the SIM sends a TextString containing 0x00 0x41 the text displayed is "0041".

16.3.3.4 Error codes

- + CME ERROR: 3 **Operation not allowed.** This error is returned when a wrong parameter is detected.
- +CME ERROR: 4 **Operation not supported.** This error is returned when the user wants to get information about a SIM ToolKit pro-active command (with SIM ToolKit functionality not activated.)
- +CME ERROR: 518 **SIM ToolKit indication not received.** This error is returned when the SIM Toolkit indication (**+STIN**) has not been received.

16.3.3.5 Example

Initially, all facilities are activated, the PIN is not required and SIM toolkit functionality is activated.

```

AT+CMEE=1           Enable the reporting of mobile equipment errors
OK
AT+WIND=15          Set Wavecom indications
OK
AT+STSF?
+STSF: 1,"5FFFFFFF7F",3   SIM ToolKit functionality activated with all facilities.
OK
+STIN: 0           The main menu has been sent from the SIM.
AT+STIN?
+STIN: 0
OK
AT+STGI=0          Get information about the main menu
+STGI: "SIM TOOLKIT MAIN MENU" Main menu contains 3 items.
+STGI: 1,3,"BANK",0
+STGI: 2,3,"QUIZ",0
+STGI: 3,3,"WEATHER",0
OK
AT+STIN?
+CME ERROR: 4
  
```

16.3.4 Unsolicited Result : SIM ToolKit Control Response (+STCR)

When the customer application makes an outgoing call or an outgoing SMS and if the call control facility is activated, CALL CONTROL and SMS CONTROL responses can be identified. This is also applicable to SS calls.

Syntax : +STCR: <Result>[,<Number>,<MODestAddr>,<TextInfo>]

Option :

<Result>

0: Control response not allowed.

1: Control response with modification.

<Number> Called number, Service Center Address or SS String in ASCII format.

<MODestAddr> MO destination address in ASCII format.

<TextInfo> Text information in ASCII format.

16.3.5 SIM ToolKit Give Response (+STGR)

16.3.5.1 Description

This command allows the application/user to select an item in the main menu, or to answer the following proactive commands :

- GET INKEY Key pressed by the user.
- GET INPUT Message entered by the user.
- SELECT ITEM Selected item.
- SETUP CALL User confirmation.
- DISPLAY TEXT User confirmation to clear the message.
- SETUP EVENT LIST Reporting events.

It is also possible to terminate the current proactive command session by sending a Terminal Response to the SIM, with the following parameters :

- BACKWARD MOVE Process a backward move
- BEYOND CAPABILITIES Command beyond ME capabilities

- UNABLE TO PROCESS ME is currently unable to process command
- NO RESPONSE No response from the user
- END SESSION User abort.

16.3.5.2 Syntax

Command syntax : +STGR=<CmdType>[,<Result>,<Data>]

| Command | Possible responses |
|--|-------------------------|
| +STGR=<CmdType>[,<Result>,<Data>] | OK +CME ERROR: <err> |
| For GetInput with <Result>=1: +STGR=3,1<CR> <Data><Ctrl Z> | OK +CME ERROR: <err> |
| For GetInkey with <Result>=1 +STGR=2,1,"<Data>" | OK +CME ERROR: <err> |
| +STGR=? | OK |

16.3.5.3 Defined values

<CmdType>

- 0: Item selection in the main menu.
- 1: User confirmation to clear a 'Disp Text'.
- 2: Response for a 'Get Inkey'.
- 3: Response for a 'Get Input'.
- 4: Response for a 'Setup call'.
- 6: Response for a 'Sel Item'.
- 11 Reponse for a 'Setup event list'.
- 95 Backward move
- 96 Command beyond ME capabilities
- 97 ME currently unable to process command
- 98 No response from the user.
- 99 User abort.

Values when CmdType=0 (Select an item from the main menu)

<Result>

- 1: Item selected by the user.
 - 2: Help information required by user.
- <Data> Contains the item identifier of the item selected by the user.

Values when CmdType=1 (Confirm the display text clearing)

No values.

Values when CmdType=2 (Get Inkey)

<Result>

- 0: Session ended by user.
- 1: Response given by the user.
- 2: Help information required by user.

<Data> Contains the key pressed by the user.

Values when CmdType=3 (Get Input)

<Result>

- 0: Session ended by user.
- 1: Response given by the user.
- 2: Help information required by user.

<Data> Contains the string of characters entered by the user.

Note:

For Inputs in UCS2 format, the data are entered in ASCII format. Example : For "8000410042FFFF" entered, the SIM receives 0x00 0x41 0x00 0x42 with UCS2 DCS. (See the Appendix E about the different UCS2 syntaxes).

Values when CmdType=4 (Setup call)

<Result>

- 0: User refuses the call.
- 1: User accepts call.

Values when CmdType=6 (Select Item)

<Result>

- 0: Session terminated by the user
- 1: Item selected by the user
- 2: Help information required by the user
- 3: Return to the back item

<Data> Contains the item identifier selected by the user

Values when CmdType=11 (Setup Event List)

<Result>

- 1: Idle screen available.
- 2: User activity event.

Sending a Terminal Response to the SIM :

Values when CmdType=95 (**Backward Move**)

Values when CmdType=96 (**Command beyond ME capabilities**)

Values when CmdType=97 (**ME currently unable to process command**)

Values when CmdType=98 (**No response from the user**)

Values when CmdType=99 (**SIM Toolkit Session aborting by the user**)

No values.

It is possible to send a Terminal Response after the **+STIN** indication (step 2, cf §16.2), or after the **+STGI** command (step 3).

Note :

*For the SETUP MENU Proactive Command, it is only possible to send a Terminal Response after the **+STIN: 0** indication, not after a **+STGI=0** request. All of the Terminal Responses are not possible with all of the Proactive Commands. Compatibility between available Terminal Responses and Proactive Commands is given in Appendix B, Table 2. If a Terminal Response is attempted during a incompatible Proactive Command session, a **+CME ERROR: 3** will be returned.*

16.3.5.4 Possible error codes

+ CME ERROR: 3 Operation not allowed. This error is returned when a wrong parameter is detected.

+CME ERROR: 4 **Operation not supported.** This error is returned when the user gives a response with SIM ToolKit functionality not activated. Or if the SIM Toolkit indication (*+STIN*) has not been received.

16.3.5.5 Example

Initially, all facilities are activated, the PIN is not required and the SIM toolkit functionality is activated.

```

+STIN: 0                The main menu has been sent from the SIM.
AT+STGI=0              Get information about the main menu
+STGI: 1,3,"BANK",0    The main menu contains 3 items.
+STGI: 2,3,"QUIZ",0
+STGI: 3,3,"WEATHER",0
OK
AT+STGR=0,1,1          The item 2 of the main menu has been selected.
OK
+STIN: 6                The Sel item menu has been sent from the SIM.
AT+STGI=6              Get information about the BANK menu
+STGI: 1,"BANK"        The BANK menu contains two items.
+STGI: 1,2,"PERSONAL ACCOUNT ENQUIRY",1
+STGI: 2,2,"NEWS",0
OK
AT+STGR=6,1,1          Select Item 1.
OK
+STIN: 3                User request to enter Password sent.
AT+STGI=3              Get information about this request.
+STGI: 0,0,4,4,0,"Enter Account Password:"
OK
AT+STGR=3,1<CR>        The user enters the Password.
>0000<Ctrl Z>
OK
+STIN: 1                A text info has been sent from the SIM.
AT+STGI=1              Get information about this text.
+STGI: 0,"Password correct, please wait for response",0
OK
+STIN: 9                SIM requests a bank account update from bank server via the
                        network (SEND SMS)
AT+STGI=9              Get all information about the SEND SMS
+STGI: "Send account balance of user, authorization ok"
OK

***** After a short period of time. *****
+STIN: 5                Transaction is complete: BEEP
+STGI=5                Get information about the Tone
+STGI: 9,1,1
+STIN: 1                Display text indication
AT+STGI=1
+STGI: 0,"Your account balance is 1000 $",0
OK
    
```

17 GPRS commands

GPRS commands are not available under GSM-only software.

17.1 Define PDP Context +CGDCONT

| Command | Possible response(s) |
|---|---|
| +CGDCONT=[<cid> [,<PDP_type> [,<APN> [,<PDP_addr> [,<d_comp> [,<h_comp>]]]]]] | OK ERROR |
| +CGDCONT? | +CGDCONT: <cid>, <PDP_type>, <APN>, <PDP_addr>, <data_comp>, <head_comp> [<CR><LF>+CGDCONT: <cid>, <PDP_type>, <APN>, <PDP_addr>, <data_comp>, <head_comp> [...]] OK |
| +CGDCONT=? | +CGDCONT: (range of supported <cid>s), <PDP_type>,,, (list of supported <d_comp>s), (list of supported <h_comp>s) [<CR><LF>+CGDCONT: (range of supported <cid>s), <PDP_type>,,, (list of supported <d_comp>s), (list of supported <h_comp>s) [...]] OK |

Description

This command specifies PDP context parameter values for a PDP context identified by the local context identification parameter, <cid>.

Four PDP contexts can be defined through Wavecom software.

A special form of the set command, +CGDCONT= <cid> causes the values for context number <cid> to become undefined.

The test command returns values supported as a compound value. If the MT supports several PDP types, <PDP_type>, the parameter value ranges for each <PDP_type> are returned on a separate line.

The read command returns the current settings for each defined context.

The test command returns values supported as a compound value. If the MT supports several PDP types, <PDP_type>, the parameter value ranges for each <PDP_type> are returned on a separate line.

Defined values

<cid>: (PDP Context Identifier) a numeric parameter (1-4) which specifies a particular PDP context definition. The parameter is local to the TE-MT interface and is used in other PDP context-related commands.

<PDP_type>: (Packet Data Protocol type) a string parameter which specifies the type of packet data protocol

- IP Internet Protocol
- PPP Point to Point Protocol

<APN>: (Access Point Name) a string parameter, which is a logical name that is used to select the GGSN or the external packet data network.

If the value is null or omitted, then the subscription value will be requested.

<PDP_address>: a string parameter that identifies the MT in the address space applicable to the PDP.

If the value is null or omitted, then a value may be provided by the TE during the PDP startup procedure or, failing that, a dynamic address will be requested.

The read form of the command will continue to return the null string even if an address has been allocated during the PDP startup procedure. The allocated address may be read using the **+CGPADDR** command.

<d_comp>: a numeric parameter that controls PDP data compression

- 0 - off (default if value is omitted)
- 1 - on
- Other values are reserved.

<h_comp>: a numeric parameter that controls PDP header compression

- 0 - off (default if value is omitted)
- 1 - on
- Other values are reserved.

NOTE. At present only one data compression algorithm (V.42bis) is provided in SNDCP. If and when other algorithms become available, a command will be provided to select one or more of these.

NOTE. 4 cids are available to specify 4 PDP contexts but only 11 NSAPI are available for PDP activation. Due to Wavecom Choice, 4 PDP contexts can be specified with only one activated at the same time.

Example

```
AT +CGDCONT=1, "IP", "internet"; +GDCONT=2, "IP", "abc.com"
```

```
OK
```

AT+CGDCONT=?

+CGDCONT=(1-4),"IP",,,(0-1),(0-1)

+CGDCONT=(1-4),"PPP",,,0,0

OK

AT+CGDCONT?

+CGDCONT=1, "IP", "internet",,0,0

+CGDCONT=2, "IP", "abc.com",,0,0

OK

17.2 Quality of Service Profile (Requested) +CGQREQ

| Command | Possible Response(s) |
|---|--|
| +CGQREQ=[<cid> [,<precedence > [,<delay> [,<reliability.> [,<peak> [,<mean>]]]]]] | OK ERROR |
| +CGQREQ? | +CGQREQ: <cid>, <precedence >, <delay>, <reliability>, <peak>, <mean> [<CR><LF>+CGQREQ: <cid>, <precedence >, <delay>, <reliability.>, <peak>, <mean> [...]] OK |
| +CGQREQ=? | +CGQREQ: <PDP_type>, (list of supported <precedence>s), (list of supported <delay>s), (list of supported <reliability>s) , (list of supported <peak>s), (list of supported <mean>s) [<CR><LF>+CGQREQ: <PDP_type>, (list of supported <precedence>s), (list of supported <delay>s), (list of supported <reliability>s) , (list of supported <peak>s), (list of supported <mean>s) [...]] OK |

Description

This command allows the TE to specify a Quality of Service Profile that is used when the MT sends an Activate PDP Context Request message to the network.

The set command specifies a profile for the context identified by the local context identification parameter, <cid>. Since this is the same parameter that is used in the +CGDCONT command, the +CGQREQ command is effectively an extension to the +CGDCONT command. The QoS profile consists of a number of parameters, each of which may be set to a separate value.

A special form of the set command, +CGQREQ= <cid> causes the requested profile for context number <cid> to become undefined.

The read command returns the current settings for each defined context. The test command returns values supported as a compound value. If the MT supports several PDP types, the parameter value ranges for each PDP type are returned on a separate line.

Defined values

<cid>: a numeric parameter which specifies a particular PDP context definition.

<precedence>: a numeric parameter which specifies the precedence class

<delay>: a numeric parameter which specifies the delay class

<reliability>: a numeric parameter which specifies the reliability class

<peak>: a numeric parameter which specifies the peak throughput class

<mean>: a numeric parameter which specifies the mean throughput class

If a value is omitted for a particular class then the value is considered to be unspecified.

Precedence

| Precedence | Precedence Name | Interpretation |
|------------|-----------------|--|
| | Subscribed | Subscribed by the Nwk / default if value is omitted |
| | High priority | Service commitments shall be maintained ahead of precedence classes 2 and 3. |
| | Normal priority | Service commitments shall be maintained ahead of precedence class 3. |
| | Low priority | Service commitments shall be maintained after precedence classes 1 and 2. |

Delay

| Delay Class | Delay (maximum values) | | | |
|------------------|---------------------------|---|---------------------------|---------------------------|
| | SDU size: 128 octets | | SDU size: 1024 octets | |
| | Mean Transfer Delay (sec) | 95 percentile Delay (sec) | Mean Transfer Delay (sec) | 95 percentile Delay (sec) |
| 1. (Predictive) | Subscribed | Subscribed by the Nwk / default if value is omitted | | |
| | < 0.5 | | < 2 | < 7 |
| 2. (Predictive) | < 5 | < 25 | < 15 | < 75 |
| 3. (Predictive) | < 50 | < 250 | < 75 | < 375 |
| 4. (Best Effort) | Unspecified | | | |

Reliability

| Reliability Class | GTP Mode | LLC Frame Mode | LLC Data Protection | RLC Block Mode | Traffic Type |
|-------------------|----------------|---|---------------------|----------------|---|
| | Subscribed | Subscribed by the Nwk / default if value is omitted | | | |
| | Acknowledged | Acknowledged | Protected | Acknowledged | Non real-time traffic, error-sensitive application that cannot cope with data loss. |
| | Unacknowledged | Acknowledged | Protected | Acknowledged | Non real-time traffic, error-sensitive application that can cope with infrequent data loss. |
| | Unacknowledged | Unacknowledged | Protected | Acknowledged | Non real-time traffic, error-sensitive application that can cope with data loss, GMM/SM, and SMS. |
| | Unacknowledged | Unacknowledged | Protected | Unacknowledged | Real-time traffic, error-sensitive application that can cope with data loss. |
| | Unacknowledged | Unacknowledged | Unprotected | Unacknowledged | Real-time traffic, error non-sensitive application that can cope with data loss. |

NOTE: For real-time traffic, the QoS profile also requires appropriate settings for delay and throughput.

Peak throughput

| Peak Throughput Class | Peak Throughput in octets per second |
|-----------------------|---|
| 0 | Subscribed by the Nwk / default if value is omitted |
| 1 | Up to 1 000 (8 kbit/s). |
| 2 | Up to 2 000 (16 kbit/s). |
| 3 | Up to 4 000 (32 kbit/s). |
| 4 | Up to 8 000 (64 kbit/s). |
| 5 | Up to 16 000 (128 kbit/s). |
| 6 | Up to 32 000 (256 kbit/s). |
| 7 | Up to 64 000 (512 kbit/s). |
| 8 | Up to 128 000 (1 024 kbit/s). |
| 9 | Up to 256 000 (2 048 kbit/s). |

Mean throughput

| Mean Throughput Class | Mean Throughput in octets per hour |
|-----------------------|---|
| 0 | Subscribed by the Nwk / default if value is omitted |
| 1 | 100 (~0.22 bit/s). |
| 2 | 200 (~0.44 bit/s). |
| 3 | 500 (~1.11 bit/s). |
| 4 | 1 000 (~2.2 bit/s). |
| 5 | 2 000 (~4.4 bit/s). |
| 6 | 5 000 (~11.1 bit/s). |
| 7 | 10 000 (~22 bit/s). |
| 8 | 20 000 (~44 bit/s). |
| 9 | 50 000 (~111 bit/s). |
| 10 | 100 000 (~0.22 kbit/s). |
| 11 | 200 000 (~0.44 kbit/s). |
| 12 | 500 000 (~1.11 kbit/s). |
| 13 | 1 000 000 (~2.2 kbit/s). |
| 14 | 2 000 000 (~4.4 kbit/s). |
| 15 | 5 000 000 (~11.1 kbit/s). |
| 16 | 10 000 000 (~22 kbit/s). |
| 17 | 20 000 000 (~44 kbit/s). |
| 18 | 50 000 000 (~111 kbit/s). |
| 31 | Best effort. |

Example

AT +CGQREQ=1,1,4,5,2,14

OK

AT+CGQREQ=?

+CGQREQ: "IP", (1-3), (1-4), (1-5), (1-9), (1-31)

+CGQREQ: "PPP", (1-3), (1-4), (1-5), (1-9), (1-31)

OK

AT+CGQREQ?

+CGQREQ: 1,1,4,5,2,14

OK

17.3 Quality of Service Profile (Minimum acceptable) +CGQMIN

| Command | Possible Response(s) |
|---|--|
| +CGQMIN=[<cid> [,<precedence > [,<delay> [,<reliability.> [,<peak> [,<mean>]]]]]] | OK ERROR |
| +CGQMIN? | +CGQMIN: <cid>, <precedence >, <delay>, <reliability>, <peak>, <mean> [<CR><LF>+CGQMIN: <cid>, <precedence >, <delay>, <reliability.>, <peak>, <mean> [...]] OK |
| +CGQMIN=? | +CGQMIN: <PDP_type>, (list of supported <precedence>s), (list of supported <delay>s), (list of supported <reliability>s) , (list of supported <peak>s), (list of supported <mean>s) [<CR><LF>+CGQMIN: <PDP_type>, (list of supported <precedence>s), (list of supported <delay>s), (list of supported <reliability>s) , (list of supported <peak>s), (list of supported <mean>s) [...]] OK |

Description

This command allows the TE to specify a minimum acceptable profile which is checked by the MT against the negotiated profile returned in the Activate PDP Context Accept message.

The set command specifies a profile for the context identified by the local context identification parameter, <cid>. Since this is the same parameter that is used in the +CGDCONT command, the +CGQMIN command is effectively an extension to the +CGDCONT command. The QoS profile consists of a number of parameters, each of which may be set to a separate value.

A special form of the set command, +CGQMIN= <cid> causes the minimum acceptable profile for context number <cid> to become undefined. In this case no check is made against the negotiated profile.

The read command returns the current settings for each defined context. The test command returns values supported as a compound value. If the MT supports several PDP types, the parameter value ranges for each PDP type are returned on a separate line.

Defined values

<cid>: a numeric parameter which specifies a particular PDP context .

<precedence>: a numeric parameter which specifies the precedence class.

<delay>: a numeric parameter which specifies the delay class.

<reliability>: a numeric parameter which specifies the reliability class.

<peak>: a numeric parameter which specifies the peak throughput class.

<mean>: a numeric parameter which specifies the mean throughput class.

If a value is omitted for a particular class then this class is not checked.

Example

```
AT +CGQMIN=1,1,4,5,2,31
```

```
OK
```

```
AT+CGQMIN=?
```

```
+CGQMIN: "IP", (1-3), (1-4), (1-5), (1-9), (1-31)
```

```
+CGQMIN: "PPP", (1-3), (1-4), (1-5), (1-9), (1-31)
```

```
OK
```

```
AT+CGQMIN?
```

```
+CGQMIN: 1,1,4,5,2,14
```

```
OK
```

17.4 GPRS attach or detach +CGATT

| Command | Possible Response(s) |
|-------------------|--|
| +CGATT= [<state>] | OK ERROR |
| +CGATT? | +CGATT: <state> OK |
| +CGATT=? | +CGATT: (list of supported <state>s) OK |

Description

The execution command is used to attach the MT to, or detach the MT from, the GPRS service. After the command has completed, the MT remains in V.25ter command state. If the MT is already in the requested state, the command is ignored and the OK response is returned. If the requested state cannot be achieved because the GPRS is not supported by the ME or the Network, an ERROR or +CME ERROR response is returned. Extended error responses are enabled by the +CMEE command.

Any active PDP contexts will be automatically deactivated when the attachment state changes to detached.

The read command returns the current GPRS service state.

The test command is used for requesting information on the supported GPRS service states.

Defined Values

<state>: indicates the state of GPRS attachment

- 0 – detached
- 1 – attached
- Other values are reserved and will result in an ERROR response to the execution command.

Example

```
AT +CGATT=1
```

```
OK
```

17.5 PDP context activate or deactivate +CGACT

| Command | Possible Response(s) |
|--|---|
| +CGACT=[<state> [,<cid>[,<cid>[,...]]]] | OK ERROR |
| +CGACT? | +CGACT: <cid>, <state> [<CR><LF>+CGACT: <cid>, <state> [...]] OK |
| +CGACT=? | +CGACT: (list of supported <state>s) OK |

Description

The execution command is used to activate or deactivate the specified PDP context (s). After the command has completed, the MT remains in V.25ter command state. If any PDP context is already in the requested state, the state for that context remains unchanged.

If the requested state for any specified context cannot be achieved, an ERROR or +CME ERROR response is returned. Extended error responses are enabled by the +CMEE command.

If the MT is not GPRS attached when the activation form of the command is executed, the MT first performs a GPRS attach and then attempts to activate the specified contexts. If the attach fails then the MT responds with ERROR or, if extended error responses are enabled, with the appropriate failure-to-attach error message.

If no <cid>s are specified the activation form of the command activates the first activable defined contexts.

If no <cid>s are specified the deactivation form of the command deactivates all active contexts.

One PDP contexts can be activated through Wavecom software at the same time.

The read command returns the current activation states for all the defined PDP contexts.

The test command is used for requesting information on the supported PDP context activation states.

Defined Values

<state>: indicates the state of PDP context activation

- 0 – deactivated
- 1 – activated
- Other values are reserved and will result in an ERROR response to the execution command.

<cid>: a numeric parameter which specifies a particular PDP context.

Example

AT +CGACT=1,1

OK

AT+CGACT?

+CGACT: 1, 1

OK

AT+CGACT=?

+CGACT: (0-1)

OK

Before a context can be activated, the MT must be attached to the GPRS network by performing an automatic GPRS attach.

17.6 Enter data state +CGDATA

| Command | Possible Response(s) |
|-----------------|----------------------|
| +CGDATA=[<cid>] | CONNECT ERROR |
| +CGDATA=? | +CGDATA: OK |

Description

The execution command causes the MT to perform whatever actions are necessary to establish communication between the TE and the network. This may include performing a GPRS attach and one PDP context activations.

If the cid value is not defined to the MT, the MT will return an ERROR or +CME ERROR response. Otherwise, the MT issues the intermediate result code CONNECT and enters V.25ter online data state.

GPRS attachment and PDP context activation procedures may take place prior to or during the PDP startup if they have not already been performed using the +CGATT and +CGACT commands.

If no <cid> is given, the MT is attempt to activate the context with whatever information is available to the MT. The other context parameters is set to their default values (No APN, default QOS parameters, dynamic IP address requested).

If the activation is successful, data transfer may proceed.

After data transfer is complete, and the layer 2 protocol termination procedure has completed successfully, the V.25ter command state is re-entered and the MT returns the final result code OK.

In the event of an erroneous termination or a failure to start up, the V.25ter command state is re-entered and the MT returns the final result code NO CARRIER or, if enabled, +CME ERROR. Attach, activate and other errors may be reported.

This command may be used in both normal and modem compatibility modes.

Remark : the goal of this command is the same than ATD*99*** so, the best will be to use only ATD*99***

Defined Values

<cid>: a numeric parameter which specifies a particular PDP context definition.

Example

AT+CGDATA=?

+CGDATA:

OK

AT +CGDATA=1

CONNECT

17.7 GPRS mobile station class +CGCLASS

| Command | Possible Response(s) |
|---------------------|--|
| +CGCLASS= [<class>] | OK ERROR |
| +CGCLASS? | +CGCLASS: <class> OK |
| +CGCLASS=? | +CGCLASS: (list of supported <class>s) OK |

Description

The set command is used to set the MT to operate according to the specified GPRS mobile class. If the requested class is not supported, an ERROR or +CME ERROR response is returned.

The read command returns the current GPRS mobile class.

The test command is used for requesting information on the supported GPRS mobile classes.

Defined Values

<class>: a string parameter which indicates the GPRS mobile class (in descending order of functionality)

A class A (highest)

B class B

CG class C in GPRS only mode

CC class C in circuit switched only mode (lowest)

Other values are reserved and will result in an ERROR response to the set command.

If the MT is GPRS attached when the set command is issued with a <class> = CC specified, a GPRS detach request is sent to the network.

If the MT is GSM attached when the set command is issued with a <class> = CG specified, a GSM detach request is sent to the network.

Class A is not supported by Wavecom GPRS software.

Remark : During switch-On in CG class, the MS always performs an automatic GPRS attach (the ATTACH-STATUS parameter of +WGPRS is ignored).

But if the MS is not already GPRS attached when switching from B/CC class to CG class then no automatic GPRS attach is performed.

Example

```
AT +CGCLASS="CG"
```

```
OK
```

To go in **GPRS class C** mode

AT +CGCLASS="CC"

OK

To go in **GSM** mode

AT +CGCLASS="A"

+CME ERROR: 150

Class chosen not supported.

AT+CGCLASS=?
+CGCLASS: ("CG","CC")

OK

AT+CGCLASS?

+CGCLASS: "CC"

OK

About the remark :

AT+CGCLASS?

+CGCLASS: "B"

OK

AT+CGATT?

+CGATT: 0

OK

AT+CGCLASS="CG"

OK

AT+CGATT?

+CGATT: 0

OK

AT+CGATT=1

OK

AT+CPOF

OK

AT+CFUN=1

OK

AT+CGCLASS?

+CGCLASS: "CG"

OK

AT+CGATT?

+CGATT: 1

OK

17.8 Select service for MO SMS messages +CGSMS

| Command | Possible Response(s) |
|---------------------|---|
| +CGSMS= [<service>] | OK ERROR |
| +CGSMS? | +CGSMS: <service> OK |
| +CGSMS=? | +CGSMS: (list of currently available <service>s) OK |

Description

The set command is used to specify the service or service preference that the MT will use to send MO SMS messages.

The read command returns the currently selected service or service preference.

The test command is used for requesting information on the currently available services and service preferences.

Defined Values

<service>: a numeric parameter which indicates the service or service preference to be used

- 0 GPRS
- 1 Circuit switched
- 2 GPRS preferred (use circuit switched if GPRS is not available)
- 3 Circuit switched preferred (use GPRS if circuit switched not available)

Other values are reserved and will result in an ERROR response to the set command.

Example

```
AT +CGSMS=0
```

```
OK
```

```
AT+CGSMS=?
```

```
+CGSMS=(0-3)
```

```
OK
```

17.9 GPRS event reporting +CGEREP

| Command | Possible response(s) |
|------------------|--|
| +CGEREP=[<mode>] | OK ERROR |
| +CGEREP? | +CGEREP: <mode> OK |
| +CGEREP=? | +CGEREP: (list of supported <mode>s) OK |

Description

Set command enables or disables sending of unsolicited result codes, +CGEV: XXX from MT to TE in the case of certain events occurring in the GPRS MT or the network.

<mode> controls the processing of unsolicited result codes specified within this command.

Read command returns the current mode and buffer settings

Test command returns the modes and buffer settings supported by the MT as compound values.

Defined values

<mode>:

0 buffer unsolicited result codes in the MT; if MT result code buffer is full, the oldest ones can be discarded. No codes are forwarded to the TE.

2 buffer unsolicited result codes in the MT when MT-TE link is reserved (e.g. in on-line data mode) and flush them to the TE when MT-TE link becomes available; otherwise forward them directly to the TE

With Wavecom's software, a combinaison of all modes is implemented. When serial link is available, indications are forwarded directly to the TE. If serial link is reserved (e.g. in on-line data mode), if MT result code buffer is full, the oldest ones can be discarded.

Defined events

The following unsolicited result codes and the corresponding events are defined:

+CGEV: REJECT <PDP_type>, <PDP_addr>

A network request for PDP context activation occurred when the MT was unable to report it to the TE with a +CRING unsolicited result code and was automatically rejected.

+CGEV: NW REACT <PDP_type>, <PDP_addr>, [<cid>]

The network has requested a context reactivation. The <cid> that was used to reactivate the context is provided if known to the MT.

+CGEV: NW DEACT <PDP_type>, <PDP_addr>, [<cid>]

The network has forced a context deactivation. The <cid> that was used to activate the context is provided if known to the MT.

+CGEV: ME DEACT <PDP_type>, <PDP_addr>, [<cid>]

The mobile equipment has forced a context deactivation. The <cid> that was used to activate the context is provided if known to the MT.

+CGEV: NW DETACH

The network has forced a GPRS detach. This implies that all active contexts have been deactivated. These are not reported separately.

+CGEV: ME DETACH

The mobile equipment has forced a GPRS detach. This implies that all active contexts have been deactivated. These are not reported separately.

+CGEV: NW CLASS <class>

The network has forced a change of MS class. The highest available class is reported.

+CGEV: ME CLASS <class>

The mobile equipment has forced a change of MS class. The highest available class is reported.

17.10 GPRS network registration status +CGREG

| Command | Possible response(s) |
|--------------|---|
| +CGREG=[<n>] | OK |
| +CGREG? | +CGREG: <n>,<stat>[,<lac>,<ci>] OK <i>+CME ERROR: <err></i> |
| +CGREG=? | +CGREG: (list of supported <n>s) OK |

Description

The set command controls the presentation of an unsolicited result code +CGREG: <stat> when <n>=1 and there is a change in the MT's GPRS network registration status, or code +CGREG: <stat>[,<lac>,<ci>] when <n>=2 and there is a change of the network cell.

The read command returns the status of result code presentation and an integer <stat> which shows whether the network has currently indicated the registration of the MT. Location information elements <lac> and <ci> are returned only when <n>=2 and MT is registered in the network.

Defined values

<n>:

- 0 disable network registration unsolicited result code
- 1 enable network registration unsolicited result code +CGREG: <stat>
- 2 enable network registration and location information unsolicited result code +CGREG: <stat>[,<lac>,<ci>]

<stat>:

- 0 not registered, ME is not currently searching a new operator to register to
- 1 registered, home network
- 2 not registered, but ME is currently searching a new operator to register to
- 3 registration denied
- 4 unknown
- 5 registered, roaming

<lac>:

string type; two byte location area code in hexadecimal format.

<ci>:

string type; two byte cell ID in hexadecimal format

17.11 Request GPRS IP service 'D'

| Command | Possible Response(s) |
|---------------------------|----------------------|
| D*<GPRS_SC_IP>[***<cid>]# | CONNECT ERROR |

Description

This command causes the MT to perform whatever actions are necessary to establish communication between the TE and the external PDN.

The V.25ter 'D' (Dial) command causes the MT to enter the V.25ter online data state and, with the TE, to start the specified layer 2 protocol. The MT return CONNECT to confirm acceptance of the command prior to entering the V.25ter online data state. No further commands may follow on the AT command line.

The detailed behaviour after the online data state has been entered is described briefly in clause 9, for IP, of GSM 07.60. GPRS attachment and PDP context activation procedures may take place prior to or during the PDP startup if they have not already been performed using the +CGATT and +CGACT commands.

If <cid> is supported, its usage is the same as in the +CGDATA command. The +CGDCONT, +CGQREQ, etc. commands may then be used in the modem initialisation AT command string to set values for for PDP type, APN, QoS etc...

If <cid> is not supported or is supported but omitted, the MT attempt to activate the context using the 'Empty PDP type' (GSM 04.08). (No PDP address or APN is sent in this case and only one PDP context subscription record is present in the HLR for this subscriber.)

Defined Values

<GPRS_SC_IP>: (GPRS Service Code for IP) a digit string (value 99), which identifies a request to use the GPRS with IP (PDP types IP and PPP)

<cid>: a digit string which specifies a particular PDP context definition.

Example

```
ATD*99***1#
```

```
CONNECT
```

```
ATD*99***2#
```

```
ERROR
```

17.12 Network requested PDP context activation

In this mode of operation, the MT behaves like an answering modem and accepts the normal V.25ter commands associated with answering a call. If GPRS-specific configuration commands are required, they may be sent to the MT as part of the modem initialisation commands.

The +CGAUTO command is used to select modem compatibility mode.

17.12.1.1 Automatic response to a network request for PDP context activation 'S0'

The V.25ter 'S0=n' (Automatic answer) command may be used to turn off (n=0) and on (n>0) the automatic response to a network request for a PDP context activation.

When the 'S0=n' (n>0) command is received, the MT attempt to perform a GPRS attach if it is not already attached. Failure will result in ERROR being returned to the TE. Subsequently, the MT will announce a network request for PDP context activation by issuing the unsolicited result code RING to the TE, followed by the intermediate result code CONNECT. The MT then enters V.25ter online data state and follows the same procedure as it would after having received a +CGANS=1 with no <L2P> or <cid> values specified.

NOTE. The 'S0=n' (n=0) command does not perform an automatic GPRS detach.

17.12.1.2 Manual acceptance of a network request for PDP context activation 'A'

The V.25ter 'A' (Answer) command may be used to accept a network request for a PDP context activation announced by the unsolicited result code RING. The MT responds with CONNECT, enters V.25ter online data state and follows the same procedure as it would after having received a +CGANS=1 with no <cid> value specified. It is an error to issue the 'A' command when there is no outstanding network request.

17.12.1.3 Manual rejection of a network request for PDP context activation 'H'

The V.25ter 'H' or 'H0' (On-hook) command may be used to reject a network request for PDP context activation announced by the unsolicited result code RING. The MT responds with OK. It is an error to issue the 'H' command when there is no outstanding network request.

NOTE: This is an extension to the usage of the 'H' command that is described in ITU-T V.25ter.

17.13 Automatic response to a network request for PDP context activation +CGAUTO

| Command | Possible response(s) |
|---------------------|--|
| +CGAUTO=[<n>] >] | OK ERROR |
| +CGAUTO? | +CGAUTO: <n> OK |
| +CGAUTO=? | +CGAUTO: (list of supported <n>s) OK |

Description

The set command disables or enables an automatic positive response (auto-answer) to the receipt of a Request PDP Context Activation message from the network. It also provides control over the use of the V.25ter basic commands 'S0', 'A' and 'H' for handling network requests for PDP context activation. The setting does not affect the issuing of the unsolicited result code RING or +CRING.

The test command returns values of <n> supported by the MT as a compound value.

When the +CGAUTO=0 command is received, the MT will not perform a GPRS detach if it is attached. Subsequently, when the MT announces a network request for PDP context activation by issuing the unsolicited result code RING or +CRING, the TE may manually accept or reject the request by issuing the +CGANS command or may simply ignore the network request.

When the +CGAUTO=1 command is received, the MT will attempt to perform a GPRS attach if it is not already attached. Failure will result in ERROR or, if enabled, +CME ERROR being returned to the TE. Subsequently, when the MT announces a network request for PDP context activation by issuing the unsolicited result code RING or +CRING to the TE, this is followed by the intermediate result code CONNECT. The MT then enters V.25ter online data state and follows the same procedure as it would after having received a +CGANS=1 with <cid> values specified.

Defined values

<n>:

- 0 turn off automatic response for GPRS only
- 1 turn on automatic response for GPRS only
- 2 modem compatibility mode, GPRS only
- 3 modem compatibility mode, GPRS and circuit switched calls (default)

For $\langle n \rangle = 0$ GPRS network requests are manually accepted or rejected by the +CGANS command.

For $\langle n \rangle = 1$ GPRS network requests are automatically accepted according to the description above.

For $\langle n \rangle = 2$, automatic acceptance of GPRS network requests is controlled by the 'S0' command. Manual control uses the 'A' and 'H' commands, respectively, to accept and reject GPRS requests. (+CGANS may also be used.) Incoming circuit switched calls can be neither manually nor automatically answered.

For $\langle n \rangle = 3$, automatic acceptance of both GPRS network requests and incoming circuit switched calls is controlled by the 'S0' command. Manual control uses the 'A' and 'H' commands, respectively, to accept and reject GPRS requests. (+CGANS may also be used.) Circuit switched calls are handled as described elsewhere in this specification.

NOTE. In class C GPRS the modem can't receive GPRS and GSM incoming calls simultaneously.

Example

```
AT+CGAUTO=?  
+CGAUTO: (0-2)  
OK
```

```
AT+CGAUTO?  
+CGAUTO: 2  
OK
```

```
AT+CGAUTO=0  
OK
```

17.14 Manual response to a network request for PDP context activation +CGANS

| Command | Possible response(s) |
|---------------------------------|---|
| +CGANS=[<response>, [<cid>]] | OK ERROR |
| +CGANS=? | +CGANS: (list of supported <response>s), (list of supported <L2P>s) OK |

Description

The execution command requests the MT to respond to a network request for GPRS PDP context activation which has been signalled to the TE by the RING or +CRING: unsolicited result code. The <response> parameter allows the TE to accept or reject the request.

If <response> is 0, the request is rejected and the MT returns OK to the TE.

If <response> is 1, the following procedure is followed by the MT.

PDP context activation procedures take place prior to or during the PDP startup. One <cid> may be specified in order to provide the values needed for the context activation request.

During the PDP startup procedure the MT has the PDP type and the PDP address provided by the network in the Request PDP Context Activation message.

If a <cid> is given his informations must matching with the PDP type and PDP address in the network request as follows -

The PDP type must match exactly.

The PDP addresses are considered to match if they are identical or if the address in the context definition is unspecified.

If any of this information is in conflict, the command will fail.

The context is activated using the values for PDP type and PDP address provided by the network, together with the other information found in the PDP context definition. An APN may or may not be required, depending on the application. If no <cid> is given, the MT will attempt to activate the context using the values for PDP type and PDP address provided by the network, together with any other relevant information known to the MT. The other context parameters will be set to their default values.

If the activation is successful, data transfer may proceed.

After data transfer is complete, and the layer 2 protocol termination procedure has completed successfully, the V.25ter command state is re-entered and the MT returns the final result code OK

In the event of an erroneous termination or a failure to startup, the V.25ter command state is re-entered and the MT returns the final result code NO CARRIER or, if enabled, +CME ERROR. Attach, activate and other errors may be reported. It is also an error to issue the +CGANS command when there is no outstanding network request.

This command may be used in both normal and modem compatibility modes.

Defined values

<response>: is a numeric parameter which specifies how the request should be responded to.

0 reject the request

1 accept and request that the PDP context be activated

If <response> is omitted it is assumed to be 0. Other values are reserved and will result in the ERROR response.

<cid>: a numeric parameter which specifies a particular PDP context definition.

Example

```
+CRING: GPRS "IP", "122.41.74.238"
```

```
AT+CGANS=1
```

```
CONNECT
```

```
AT+CGANS=?
```

```
+CGANS= (0-1)
```

```
OK
```

17.15 Show PDP address +CGPADDR

| Command | Possible response(s) |
|----------------------------------|---|
| +CGPADDR=[<cid> [,<cid> [,...]]] | +CGPADDR: <cid>,<PDP_addr> [<CR><LF>+CGPADDR: <cid>,<PDP_addr> [...]] OK |
| +CGPADDR=? | +CGPADDR: (list of defined <cid>s) OK |

Description

The execution command returns a list of PDP addresses for the specified context identifiers.

The test command returns a list of defined <cid>s

Defined values

<cid>: a numeric parameter which specifies a particular PDP context definition. If no <cid> is specified, the addresses for all defined contexts are returned.

<PDP_address>: a string that identifies the MT in the address space applicable to the PDP. The address may be static or dynamic. For a static address, it will be the one set by the +CGDCONT command when the context was defined. For a dynamic address it will be the one assigned during the last PDP context activation that used the context definition referred to by <cid>. <PDP_address> is omitted if none is available.

Example

```
AT+CGPADDR=1
+CGPADDR=1,"107.210.5.4"
OK
```

```
AT+CGPADDR=?
+CGAPDDR= (1-32)
OK
```

```
AT+CGPADDR
+CGPADDR: 1,
+CGPADDR: 2, "10.3.73.151"
+CGPADDR: 3,
+CGPADDR: 4,
```

17.16 Cellular result codes +CRC

Description :

This command enables a more detailed ring indication, in case of incoming call (voice or data). Instead of the string "RING", an extended string is used to indicate which type of call is ringing (e.g. +CRING: VOICE).

These extended indications are :

| | |
|-------------------|----------------------------------|
| +CRING: ASYNC | for asynchronous transparent |
| +CRING: REL ASYNC | for asynchronous non-transparent |
| +CRING: VOICE | for normal speech. |
| +CRING : FAX | for fax calls |

New indication for GPRS is :

- GPRS : (GPRS network request for PDP context activation).

If the MT is unable to announce to the TE the network's request (for example it is in V.25ter online data state) the MT reject the request. No corresponding unsolicited result code is issued when the MT returns to a command state.

Example

+CRING: GPRS

17.17 Service reporting control +CR

Description :

This command enables a more detailed service reporting, in case of data **incoming or outgoing call**. Before sending the CONNECT response to the application, the GSM module will precise the type of data connection that have been established.

These report types are :

| | |
|----------------|----------------------------------|
| +CR: ASYNC | For asynchronous transparent |
| +CR: REL ASYNC | For asynchronous non-transparent |

New indication for GPRS is : GPRS

Syntax

Command syntax : AT+CR

| Command | Possible responses |
|--|-----------------------------------|
| AT+CR=0 <i>Note : Extended reports disabled</i> | OK <i>Note : Command valid</i> |
| AT+CR=1 <i>Note : Extended reports enabled</i> | OK <i>Note : Command valid</i> |

Example

+CR: GPRS

17.18 Extended error report +CEER

Description

This command gives the reason of the call release when the last call setup (originating or answering) failed.

New indication for GPRS is the reason of the last unsuccessful PDP context activation and the last GPRS detach or PDP context activation.

Syntax

Command syntax : AT+CEER

| Command | Possible responses |
|--|---|
| ATD123456789 ; <i>Note : Outgoing voice call</i> | NO CARRIER <i>Note : Call setup failure</i> |
| AT+CEER <i>Note : Ask for reason of release</i> | +CEER : Error <xxx> OK <i>Note : <xxx>is the cause information element values form GSM recommandation 04.08 or specific Call accepted</i> |

The cause information element from GSM 04.08 is given below in chapter 22 for specific GPRS failure causes.

The "NO CARRIER" indicates that the AT+CEER information is available for a failure diagnostic.

17.19 PDP Counters Infos +CGCOUNTERS

Description

This command enable or disable the spontaneous sending of the last PDP deactivated counters. These counters are related to connection time of a PDP context or data volumes sent and received during a PDP context life (ie between is activation and deactivation). **NOT IMPLEMENTED IN CURRENT VERSION**

Syntax

Command syntax : AT+CGCOUNTERS

| | |
|---|---|
| AT+CGCOUNTERS=0 <i>Note : PDP Counters infos disabled</i> | OK <i>Note : Command valid</i> |
| AT+CGCOUNTERS=1 <i>Note : PDP Counters Infos enabled</i> | OK <i>Note : Command valid</i> |
| AT+CGCOUNTERS=? | +CGCOUNTERS: (0-1) OK |
| AT+CGCOUNTERS? Note: The last PDP counters infos in memory | +CGCOUNTERS: <cid>, <PDP Context Time>, <Data IN>, <Data OUT> OK |

Example

```
AT+CGCOUNTERS?
+CGCOUNTERS: <1>, <55>, <1520 >, <122>
```

Defined Values

<PDP Context Time> : duration between the activation and deactivation of the PDP context in secondes

<Data IN> : data volume received by the MS in Kb

<Data OUT> : data volume sent by the MS in Kb

17.20 GPRS PARAMETERS CUSTO : +WGPRS

Description

This command modify some Wavecom GPRS parameters as the ATTACH-STATUS (the ME don't make automatically a GPRS attachment after init : yes/no), the PDP-INIT-STATUS (activate automatically some define PDP Contexts after init : yes/no) and the use (yes/no) of NAT (IP address translation on PPP).

In addition this command permit to set "ACTIVABLE" automatically after init some define PDP contexts.

The Wismo must be reboot to activate the new setup.

Syntax

Command syntax : AT+WGPRS

| | |
|-------------------------------------|---|
| AT+WGPRS=<mode>,<parameter>,[<cid>] | OK ERROR |
| AT+WGPRS=? | +WGPRS: <mode>, <parameter1>,[<cid>] [<CR><LF>+WGPRS: <mode>, <parameter>,[<cid>] [...]] OK |
| AT+WGPRS? | +WGPRS:<mode>(list of supported <parameter>),[(list of supported <cid>)] [<CR><LF>+WGPRS:<mode> (list of supported <parameter>),[(list of supported <cid>)] [...]] OK |

Defined Values

<mode>: a numeric parameter which specifies a Wavecom GPRS parameter :
 0 - ATTACH-STATUS (the ME don't make automatically a GPRS attachment after init)

1 - PDP-INIT-STATUS (activate automatically some define PDP Contexts after init)

2 - Set ACTIVABLE automatically after init a define PDP context

3 - NAT

<parameter> : a numeric parameter that control the <mode>

0 - Off

1 - On

<cid> : (PDP Context Identifier) a numeric parameter (1-32) which specifies a particular PDP context definition. The parameter is local to the TE-MT interface and is used in other PDP context-related commands.

Example

```
AT+WGPRS=2,1,3
```

```
OK
```

```
AT+WGPRS=?
```

```
+WGPRS: (0-3),(0-1),(0-4)
```

```
OK
```

```
AT+WGPRS?
```

```
+WGPRS: 0,0
```

```
+WGPRS: 1,0
```

```
+WGPRS: 2,1,1
```

```
+WGPRS: 2,0,2
```

```
+WGPRS: 2,0,3
```

```
+WGPRS: 2,0,4
```

```
+WGPRS: 3,1
```

```
OK
```

17.21 GPRS-related errors +CME ERROR: <error>**17.21.1 Errors related to a failure to perform an Attach**

| Numeric | Text |
|---------|---|
| 103 | Illegal MS (#3) |
| 106 | Illegal ME (#6) |
| 107 | GPRS services not allowed (#7) |
| 111 | PLMN not allowed (#11) |
| 112 | Location area not allowed (#12) |
| 113 | Roaming not allowed in this location area (#13) |

(Values in parentheses are GSM 04.08 cause codes.)

17.21.2 Errors related to a failure to Activate a Context

| Numeric | Text |
|---------|---|
| 132 | service option not supported (#32) |
| 133 | requested service option not subscribed (#33) |
| 134 | service option temporarily out of order (#34) |
| 149 | PDP authentication failure |
| 533 | Missing or Unknown APN |

(Values in parentheses are GSM 04.08 cause codes.)

17.21.3 Other GPRS errors

| Numeric | Text |
|---------|------------------------|
| 150 | invalid mobile class |
| 148 | unspecified GPRS error |

Other values in the range 101 - 150 are reserved for use by GPRS
Also all other values below 256 are reserved

17.22 Specific GPRS Failure Cause for +CEER

| Numeric | Text |
|---------|--|
| 224 | MS requested detach |
| 225 | NWK requested Detach |
| 226 | Unsuccessful attach cause NO SERVICE |
| 227 | Unsuccessful attach cause NO ACCESS |
| 228 | Unsuccessful attach cause GPRS SERVICE REFUSED |
| 229 | PDP deactivation requested by Nwk |
| 230 | PDP deactivation cause LLC link activation failed |
| 231 | PDP deactivation cause NWK reactivation with same TI |
| 232 | PDP deactivation cause GMM abort |
| 233 | PDP deactivation cause LLC or SNDSCP failure |
| 234 | PDP unsuccessful activation cause GMM error |
| 235 | PDP unsuccessful activation cause NWK reject |
| 236 | PDP unsuccessful activation cause NO NSAPI available |
| 237 | PDP unsuccessful activation cause SM refuse |
| 238 | PDP unsuccessful activation cause MMI ignore |

17.23 Full AT commands examples

17.23.1 Activation of an IP PDP context

```
AT +CGDCONT=1, "IP", "internet"; +GCDCONT=2, "IP", "abc.com"
```

```
OK
```

```
ATD*99***1#
```

```
CONNECT
```

Other example :

```
AT +CGCLASS="CG"
```

```
OK
```

```
+CGREG: 1
```

```
AT +CGDCONT=1, "IP", "internet"
```

```
OK
```

```
AT +CGQREQ=1,1,4,5,2,14
```

```
OK
```

```
AT +CGQMIN=1,1,4,5,2,14
```

```
OK
```

```
AT +CGATT=1
```

```
OK
```

AT +CGACT=1,1

OK

//Remark about +CGDATA : the goal of this command is the same than ATD*99***
so, the best will be to use only //ATD*99***

AT +CGDATA=1

CONNECT

.....

Data transfert

.....

+CGEV: NW DETACH

17.23.2 Network request

AT+CGAUTO=0

OK

+CRING: GPRS "IP", "211.45.89.152"

AT+CGANS=1

CONNECT

.....

Data transfert

18 Other AT commands

18.1 V.25 ter recommendation

The commands not listed in this document are not supported. For these commands, the product will then answer with "ERROR". All modulation control, error control and data compression commands are not recognized. An "ERROR" string will be returned.

18.2 GSM 07.05 recommendation

All the 07.05 commands not described in this manual are not implemented. The product will then answer "ERROR" to these commands.

18.3 GSM 07.07 recommendation

All the 07.07 commands not described in this manual are not implemented. The product will then answer "ERROR" to these commands.

19 Appendices

19.1 ME error result code : +CME ERROR: <error>

| <error> | Meaning | Resulting from the following commands |
|---------|--|---|
| 3 | Operation not allowed | All GSM 07.07 commands (+CME ERROR: 3) |
| 4 | Operation not supported | All GSM 07.07 commands (+CME ERROR: 4) |
| 5 | PH-SIM PIN required (SIM lock) | All GSM 07.07 commands (+CME ERROR: 5) |
| 10 | SIM not inserted | All GSM 07.07 commands (+CME ERROR: 10) |
| 11 | SIM PIN required | All GSM 07.07 commands (+CME ERROR: 11) |
| 12 | SIM PUK required | All GSM 07.07 commands (+CME ERROR: 12) |
| 13 | SIM failure | All GSM 07.07 commands (+CME ERROR: 13) |
| 16 | Incorrect password | +CACM, +CAMM, +CPUC, +CLCK, +CPWD, +CPIN, +CPIN2 (+CME ERROR: 16) |
| 17 | SIM PIN2 required | +CPBW (FDN), +CLCK (FDN), |
| 18 | SIM PUK2 required | +CACM, +CAMM, +CPUC, +CPBW (FDN), +CPIN, +CPIN2, +CLCK (FDN), +CPWD |
| 20 | Memory full | +CPBW |
| 21 | Invalid index | +CPBR, +CPBW, ATD>[mem]index, +WMGO |
| 22 | Not found | +CPBF, +CPBP, +CPBN, +CGSN, +WOPN, ATD>[mem]"name" |
| 24 | Text string too long | +CPBW, +CPIN, +CPIN2, +CLCK, +CPWD |
| 26 | Dial string too long | +CPBW, ATD, +CCFC |
| 27 | Invalid characters in dial string | +CPBW |
| 30 | No network service | +VTS, +COPS=?, +CLCK, +CCFC, +CCWA, +CUSD |
| 32 | Network not allowed – emergency calls only | +COPS |

| | | |
|-----|---|---|
| 40 | Network personalization PIN required (Network lock) | All GSM 07.07 commands (+CME ERROR: 40) |
| 103 | Illegal MS (#3) | +CGATT |
| 106 | Illegal ME (#6) | +CGATT |
| 107 | GPRS services not allowed (#7) | +CGATT |
| 111 | PLMN not allowed (#11) | +CGATT |
| 112 | Location area not allowed (#12) | +CGATT |
| 113 | Roaming not allowed in this location area (#13) | +CGATT |
| 132 | service option not supported (#32) | +CGACT +CGDATA ATD*99 |
| 133 | requested service option not subscribed (#33) | +CGACT +CGDATA ATD*99 |
| 134 | service option temporarily out of order (#34) | +CGACT +CGDATA ATD*99 |
| 149 | PDP authentication failure | +CGACT +CGDATA ATD*99 |
| 150 | invalid mobile class | +CGCLASS +CGATT |
| 148 | unspecified GPRS error | All GPRS commands |

19.2 Message service failure result code: +CMS ERROR : <er>

<er> is defined as below :

| <er> | Meaning | Resulting from the following commands |
|----------|--|--|
| 1 to 127 | Error cause values from the GSM recommendation 04.11 Annex E-2 | +CMGS, +CMSS |
| 301 | SMS service of ME reserved | +CSMS (with +CMS: ERROR 301) |
| 302 | Operation not allowed | All SMS commands (+CMSS, +CMGL, +CPMS, +CSMP...) |
| 303 | Operation not supported | All SMS commands |
| 304 | Invalid PDU mode parameter | +CMGS, +CMGW |
| 305 | Invalid text mode parameter | +CMGS, +CMGW, +CMSS |
| 310 | SIM not inserted | All SMS commands |
| 311 | SIM PIN required | All SMS commands |
| 312 | PH-SIM PIN required | All SMS commands |
| 313 | SIM failure | All SMS commands |
| 316 | SIM PUK required | All SMS commands |
| 317 | SIM PIN2 required | All SMS commands |
| 318 | SIM PUK2 required | All SMS commands |
| 321 | Invalid memory index | +CMGR, +CMSS, +CMGD |
| 322 | SIM memory full | +CMGW |
| 330 | SC address unknown | +CSCA?, +CMSS, +CMGS |
| 340 | no +CNMA acknowledgement expected | +CNMA |

19.3 Specific error result codes

| <error> | Meaning | Resulting from the following commands |
|---------|---|--|
| 500 | unknown error. | All commands |
| 512 | MM establishment failure (for SMS). | +CMGS, +CMSS (+CMS ERROR: 512) |
| 513 | Lower layer failure (for SMS) | +CMGS, +CMSS (+CMS ERROR: 513) |
| 514 | CP error (for SMS). | +CMGS, +CMSS (+CMS ERROR: 514) |
| 515 | Please wait, init or command processing in progress. | All commands ("+CME ERROR: 515" or "+CMS ERROR: 515") |
| 517 | SIM Toolkit facility not supported. | +STGI |
| 518 | SIM Toolkit indication not received. | +STGI |
| 519 | Reset the product to activate or change a new echo cancellation algo. | +ECHO, +VIP |
| 520 | Automatic abort about get plmn list for an incoming call. | +COPS=? |
| 526 | PIN deactivation forbidden with this SIM card. | +CLCK |
| 527 | Please wait, RR or MM is busy. Retry your selection later. | +COPS |
| 528 | Location update failure. Emergency calls only. | +COPS |
| 529 | PLMN selection failure. | +COPS |

| | | |
|-----|---|--------------------------------|
| | Emergency calls only. | |
| 531 | SMS not sent : the <da> is not in FDN phonebook, and FDN lock is enabled. (for SMS) | +CMGS, +CMSS (+CMS ERROR: 531) |
| 532 | the embedded application is activated so the objects flash are not erased | +WOPEN |
| 533 | Missing or Unknown APN | ATD*99 +GACT +CGDATA |

19.4 Failure Cause from GSM 04.08 recommendation (+CEER)

| Cause value | Diagnostic |
|-------------|--|
| 1 | Unassigned (unallocated) number |
| 3 | No route to destination |
| 6 | Channel unacceptable |
| 8 | Operator determined barring |
| 16 | Normal call clearing |
| 17 | User busy |
| 18 | No user responding |
| 19 | User alerting, no answer |
| 21 | Call rejected |
| 22 | Number changed |
| 26 | Non selected user clearing |
| 27 | Destination out of order |
| 28 | Invalid number format (incomplete number) |
| 29 | Facility rejected |
| 30 | Response to STATUS ENQUIRY |
| 31 | Normal, unspecified |
| 34 | No circuit/channel available |
| 38 | Network out of order |
| 41 | Temporary failure |
| 42 | Switching equipment congestion |
| 43 | Access information discarded |
| 44 | Requested circuit/channel not available |
| 47 | Resources unavailable, unspecified |
| 49 | Quality of service unavailable |
| 50 | Requested facility not subscribed |
| 55 | Incoming calls barred with in the CUG |
| 57 | Bearer capability not authorized |
| 58 | Bearer capability not presently available |
| 63 | Service or option not available, unspecified |
| 65 | Bearer service not implemented |
| 68 | ACM equal to or greater than ACMmax |
| 69 | Requested facility not implemented |
| 70 | Only restricted digital information bearer capability is available |
| 79 | Service or option not implemented, unspecified |
| 81 | Invalid transaction identifier value |
| 87 | User not member of CUG |
| 88 | Incompatible destination |
| 91 | Invalid transit network selection |
| 95 | Semantically incorrect message |
| 96 | Invalid mandatory information |

| | |
|-----|--|
| 97 | Message type non-existent or not implemented |
| 98 | Message type not compatible with protocol state |
| 99 | Information element non-existent or not implemented |
| 100 | Conditional IE error |
| 101 | Message not compatible with protocol state |
| 102 | Recovery on timer expiry |
| 111 | Protocol error, unspecified |
| 127 | Interworking, unspecified |
| 224 | MS requested detach |
| 238 | PDP unsuccessful activation cause MMI ignore |
| 239 | NWK requested Detach |
| 240 | Unsuccessful attach cause NO SERVICE |
| 241 | Unsuccessful attach cause NO ACCESS |
| 242 | Unsuccessful attach cause GPRS SERVICE REFUSED |
| 243 | PDP deactivation requested by Nwk |
| 244 | PDP deactivation cause LLC link activation failed |
| 245 | PDP deactivation cause NWK reactivation with same TI |
| 246 | PDP deactivation cause GMM abort |
| 247 | PDP deactivation cause LLC or SNDSCP failure |
| 248 | PDP unsuccessful activation cause GMM error |
| 249 | PDP unsuccessful activation cause NWK reject |
| 250 | PDP unsuccessful activation cause NO NSAPI available |
| 251 | PDP unsuccessful activation cause SM refuse |

All other values in the range 0 to 31 shall be treated as cause 31.
 All other values in the range 32 to 47 shall be treated as cause 47.
 All other values in the range 48 to 63 shall be treated as cause 63.
 All other values in the range 64 to 79 shall be treated as cause 79.
 All other values in the range 80 to 95 shall be treated as cause 95.
 All other values in the range 96 to 111 shall be treated as cause 111.
 All other values in the range 112 to 127 shall be treated as cause 127.

19.5 Specific Failure Cause for +CEER

| | |
|-----|--|
| 240 | FDN is active and number is not in FDN |
| 241 | Call operation not allowed |
| 252 | Call barring on outgoing calls |
| 253 | Call barring on incoming calls |
| 254 | Call impossible |
| 255 | Lower layer failure |

19.6 GSM 04.11 Annex E-2: Mobile originating SM-transfer

These error causes could appear for **SMS commands** (+CMGS, +CMSS, +CMGD...)

Cause no 1: "Unassigned (unallocated) number"

This cause indicates that the destination requested by the Mobile Station cannot be reached because, although the number is in a valid format, it is not currently assigned (allocated).

Cause no 8: "Operator determined barring"

This cause indicates that the MS has tried to send a mobile originating short message when the MS's network operator or service provider has forbidden such transactions.

Cause no 10: "Call barred"

This cause indicates that the outgoing call barred service applies to the short message service for the called destination.

Cause no 21: "Short message transfer rejected"

This cause indicates that the equipment sending this cause does not wish to accept this short message, although it could have accepted the short message since the equipment sending this cause is neither busy nor incompatible.

Cause no 27: "Destination out of service"

This cause indicates that the destination indicated by the Mobile Station cannot be reached because the interface to the destination is not functioning correctly. The term "not functioning correctly" indicates that a signaling message was unable to be delivered to the remote user; e.g., a physical layer or data link layer failure at the remote user, user equipment off-line, etc.

Cause no 28: "Unidentified subscriber"

This cause indicates that the subscriber is not registered in the PLMN (e.g.. IMSI not known)

Cause no 29: "Facility rejected"

This cause indicates that the facility requested by the Mobile Station is not supported by the PLMN.

Cause no 30: "Unknown subscriber"

This cause indicates that the subscriber is not registered in the HLR (e.g.. IMSI or directory number is not allocated to a subscriber).

Cause no 38: "Network out of order"

This cause indicates that the network is not functioning correctly and that the condition is likely to last a relatively long period of time; e.g., immediately reattempting the short message transfer is not likely to be successful.

Cause no 41: "Temporary failure"

This cause indicates that the network is not functioning correctly and that the condition is not likely to last a long period of time; e.g., the Mobile Station may wish to try another short message transfer attempt almost immediately.

Cause no 42: "Congestion"

This cause indicates that the short message service cannot be serviced because of high traffic.

Cause no 47: "Resources unavailable, unspecified"

This cause is used to report a resource unavailable event only when no other cause applies.

Cause no 69: "Requested facility not implemented"

This cause indicates that the network is unable to provide the requested short message service.

Cause no 81: "Invalid short message transfer reference value"

This cause indicates that the equipment sending this cause has received a message with a short message reference which is not currently in use on the MS-network interface.

Cause no 95: "Invalid message, unspecified"

This cause is used to report an invalid message event only when no other cause in the invalid message class applies.

Cause no 96: "Invalid mandatory information"

This cause indicates that the equipment sending this cause has received a message where a mandatory information element is missing and/or has a content error (the two cases are undistinguishable).

Cause no 97: "Message type non-existent or not implemented"

This cause indicates that the equipment sending this cause has received a message with a message type it does not recognize either because this is a message not defined or defined but not implemented by the equipment sending this cause.

Cause no 98: "Message not compatible with short message protocol state"

This cause indicates that the equipment sending this cause has received a message such that the procedures do not indicate that this is a permissible message to receive while in the short message transfer state.

Cause no 99: "Information element non-existent or not implemented"

This cause indicates that the equipment sending this cause has received a message which includes unrecognized information elements because the information element identifier is not defined or it is defined but not implemented by the equipment sending the cause.

However, the information element is not required to be present in the message so that the equipment sends the cause to process the message.

Cause no 111: "Protocol error, unspecified"

This cause is used to report a protocol error event only when no other cause applies.

Cause no 127: "Interworking, unspecified"

This cause indicates that there has been interworking with a network which does not provide causes for actions it takes; thus, the precise cause for a message which is being sent cannot be ascertained.

All values other than specified should be treated as error Cause No 41

19.7 Unsolicited result codes

| Verbose result code | Numeric (VO set) | Description |
|--|-----------------------|--|
| +CALA: < time string>,<index> | As verbose | Alarm notification |
| +CBM: <length><pdu> (PDU) or +CBM:<sn>,<mid>,<dcs>,<page>,<pages>... (Text mode) | As verbose | Cell Broadcast Message directly displayed |
| +CBMI: "BM",<index> | As verbose | Cell Broadcast Message stored in mem at location <index> |
| +CCCM : <ccm> | As verbose | Current Call Meter value |
| +CCED: <values> | As verbose (specific) | Cell Environment Description indication |
| +CCWA : <number>,<type>, <class> [,<alpha>] | As verbose | Call Waiting number |
| +CDS: <fo>, <mr>... (text mode) or +CDS: <length>,... (PDU) | As verbose | SMS status report after sending a SMS |
| +CDSI: <mem>,<index> | As verbose | Incoming SMS Status Report after sending a SMS, stored in <mem> ("SR") at location <index> |
| +CKEV: <keynb> | As verbose | Key press or release |
| +CLIP : <number>, <type> [,,<alpha>] | As verbose | Incoming Call Presentation |
| +CMT: <oa>... (text mode) or +CMT: [<alpha>,...] (PDU) | as verbose | Incoming message directly displayed |
| +CMTI: <mem>,<index> | as verbose | Incoming message stored in <mem> ("SM") at location <index> |
| +CREG : <stat> [,<lac>,<ci>] | As verbose | Network registration indication |
| +CRING : <type> | As verbose | Incoming call type (VOICE, FAX ...) |
| +CSQ: <RxLev>,99 | As verbose | Automatic RxLev indication with AT+CCED=1,8 command |
| +CSSU: <code2>[<number>,<type>] | As verbose | Supplementary service notification during a call |
| +STIN: <ind> | As verbose (specific) | SIM Toolkit Indication |
| +WIND: <IndicationNb> [,<CallId>] | As verbose (specific) | Specific unsolicited indication (SIM Insert/Remove, End of init, Reset, Alerting, Call creation/release) |
| +WVMI: <LinId>,<Status> | As verbose (specific) | Voice Mail Indicator notification (cf. +CPHS command) |
| +RUI: <UserInfo> | As Verbose (specific) | Receive additional User Info on a MT call setup, or a remote call release |
| RING | 2 | Incoming call signal from network |

19.8 Final result codes

| Verbose result code | Numeric (VO set) | Description |
|---------------------|------------------|--|
| +CME ERROR: <err> | As verbose | Error from GSM 07.05 commands |
| +CMS ERROR: <err> | As verbose | Error from SMS commands (07.07) |
| BUSY | 7 | Busy signal detected |
| ERROR | 4 | Command not accepted |
| NO ANSWER | 8 | Connection completion timeout |
| NO CARRIER | 3 | Connection terminated |
| OK | 0 | Acknowledges correct execution of a command line |
| RING | 2 | Incoming call signal from network |

19.9 Intermediate result codes

| Verbose result code | Numeric (V0 set) | Description |
|----------------------------|------------------|--|
| +COLP : <number> , <type> | as verbose | Outgoing Call Presentation |
| +CR : <type> | as verbose | Outgoing Call report control |
| +ILRR: <rate> | as verbose | Local TA-TE data rate |
| CONNECT 300 | 10 | Data connection at 300 bauds |
| CONNECT 1200 | 11 | Data connection at 1200 bauds |
| CONNECT 1200/75 | 12 | Data connection at 1200/75 bauds |
| CONNECT 2400 | 13 | Data connection at 2400 bauds |
| CONNECT 4800 | 14 | Data connection at 4800 bauds |
| CONNECT 9600 | 15 | Data connection at 9600 bauds |
| CONNECT 14400 | 16 | Data connection at 14400 bauds |
| +CSSI: <code1> [, <index>] | As verbose | Supplementary service notification during a call setup |

19.10 Parameters storage

| Command | Parameters storage mode | | | | Default values |
|---------|-------------------------|---------------|--------------------|-----------------|----------------|
| | AT&W (E2P) | Command (E2P) | AT+CSAS (SIM, E2P) | AT&F (SIM, E2P) | |

| General commands | | | | | |
|------------------|---|---|--|---|---------------|
| +CSCS | X | | | X | "PCCP437" |
| +WPCS | X | | | X | "TRANSPARENT" |
| +CMEE | X | | | X | 0 |
| +CRSL | | X | | X | 6 |

| Call Control commands | | | | | |
|-----------------------|---|---|--|---|---|
| %D | | X | | X | 0 |
| ATSO | X | | | X | 0 (no auto-answer) |
| +CICB | X | | | X | 2 (speech) |
| +CSNS | X | | | X | 0 (voice) |
| +VGR | X | | | X | 64 (speaker 1) 32 (speaker 2) |
| +VGT | X | | | X | 64 (mic 1 & ctrl 1) 0 (others) |
| +SPEAKER | X | | | X | 0 (Spk 1 & Mic 1) |
| +ECHO | | X | | X | ,1,0,3,10,7 (Algo ID 1) ,3,30,8000,256 (Algo ID 3) |
| +SIDET | X | | | X | 1,1 |

| Network Service commands | | | | | |
|--------------------------|---|---|--|---|-----|
| +COPS | X | X | | X | 0,2 |
| +CREG | X | | | X | 0 |

| Phonebook commands | | | | | |
|--------------------|---|---|--|---|---|
| +WAIP | X | | | X | 0 |
| +CSVM | | X | | X | 0 |

| Parameters storage mode | | | | | |
|-------------------------|---------------|------------------|-----------------------|--------------------|----------------|
| Command | AT&W (E2P) | Command (E2P) | AT+CSAS (SIM, E2P) | AT&F (SIM, E2P) | Default values |

| SMS commands | | | | | |
|--------------|---|---|---|---|----------------------------|
| +CSMS | | X | | | 0 |
| +CMGF | X | | | X | 1 (text) |
| +CSDH | X | | | X | 0 |
| +CNMI | | | X | X | 0,1,0,0,0 |
| +CSMP | | | X | X | 1,167,0,0 |
| +CSCA | | | X | | SIM dependant (phase 2) |
| +WUSS | | X | | X | 0 |

| Supplementary Services commands | | | | | |
|---------------------------------|---|---|--|---|-------|
| +CCWA | X | | | X | 0 |
| +CLIP | X | | | X | 0 |
| +COLP | X | | | X | 0 |
| +CSSN | X | | | X | 0,0 |
| +CUSD | | X | | X | 0 |
| +CCUG | | X | | | 0,0,0 |

| Data commands | | | | | |
|---------------|---|--|--|---|--------------|
| +CBST | X | | | X | 0,0,1 |
| +CR | X | | | X | 0 |
| +CRC | X | | | X | 0 |
| +ILRR | X | | | X | 0 |
| +CRLP | X | | | X | 61,61,48,6,1 |
| +DOPT | X | | | X | 1,1 |
| %C | X | | | X | 0 |
| +DS | X | | | X | 3,0,4096,20 |
| +DR | X | | | X | 0 |
| \N | X | | | X | 0 |

| Parameters storage mode | | | | | |
|-------------------------|---------------|------------------|-----------------------|--------------------|----------------|
| Command | AT&W (E2P) | Command (E2P) | AT+CSAS (SIM, E2P) | AT&F (SIM, E2P) | Default values |

| Fax Class 2 commands | | | | | |
|----------------------|---|--|--|---|-------------------|
| +FBOR | X | | | X | 0 |
| +FCQ | X | | | X | 0 |
| +FCR | X | | | X | 1 |
| +FDCC,+FDIS | X | | | X | 0,5,0,0,2,0,0,0,0 |
| +FPHCTO | X | | | X | 30 |

| V24 - V25 commands | | | | | |
|--------------------|---|--|--|---|------|
| +IPR | X | | | | 9600 |
| +ICF | X | | | | 3,4 |
| +IFC | X | | | | 2,2 |
| E | X | | | | 1 |
| &C | X | | | | 1 |
| &D | X | | | | 1 |
| &S | X | | | | 1 |
| Q | X | | | X | 0 |
| V | X | | | X | 1 |
| E | X | | | | 1 |
| wmux | X | | | X | 0 |

| Specific commands | | | | | |
|-------------------|---|---|--|---|---|
| +WIND | | X | | X | 0 |
| +ADC | | X | | X | 0 |
| +CMER | X | | | X | 0 |
| +WIOM | | X | | | 255,0 |
| +WVR | | X | | | 5 |
| +WDR | | X | | | 2 |
| +WSVG | | X | | X | 0 |
| +WRIM | | X | | X | 0 |
| +WCDM | | X | | X | 0,0 |
| +CPHS | | X | | X | ,0 |
| +WBCM | | X | | X | 0,0,4200,3300,100,50 00,0 |
| +WOPEN | | X | | | 0 |
| +WBM | | X | | | 0,0 for SPI bus 0,4 for I2C Soft bus |

| Parameters storage mode | | | | | |
|-------------------------|------------|---------------|--------------------|-----------------|----------------|
| Command | AT&W (E2P) | Command (E2P) | AT+CSAS (SIM, E2P) | AT&F (SIM, E2P) | Default values |

| SIM Toolkit commands | | | | | |
|----------------------|--|---|--|--|--------------------|
| +STSF | | X | | | 0,"160060C01F",3,0 |

19.11 GSM sequences list

In accordance with **GSM 02.30**, the product supports the following GSM sequences, which can be used through the ATD and the +CKPD commands.

19.11.1 Security

| | |
|---------------------------------------|----------------------|
| **04*OLDPIN*NEWPIN*NEWPIN# | Change PIN code |
| **042*OLDPIN2*NEWPIN2*NEWPIN2# | Change PIN2 code |
| **05*PUK*NEWPIN*NEWPIN# | Unlock PIN code |
| **052*PUK2*NEWPIN2*NEWPIN2# | Unlock PIN2 code |
| *#06# | Show the IMEI number |

19.11.2 Call forwarding

| | |
|--|-----------------------------|
| *SC# | Activate |
| **SC*PhoneNumber# or **SC*PhoneNumber*BS# or **SC*PhoneNumber*[BS]*T# | Register and activate |
| *#SC# or *#SC**BS# | Check status |
| #SC# | Deactivate |
| ##SC# or ##SC**BS# | Unregistered and deactivate |

The Service codes (SC) are:

| | |
|------------|----------------------------------|
| 002 | all call forwarding |
| 004 | all conditional call forwarding |
| 21 | call forwarding unconditional |
| 61 | call forwarding on no answer |
| 62 | call forwarding on not reachable |
| 67 | call busy |

The Network service codes (BS) are:

| | |
|----------------|-------------------------------|
| No code | All tele and bearer services |
| 10 | All teleservices |
| 11 | Telephony |
| 12 | All data teleservices |
| 13 | Fax services |
| 16 | Short Message Services |
| 19 | All teleservices except SMS |
| 20 | All bearer services |
| 21 | All asynchronous services |
| 22 | All synchronous services |
| 24 | All data circuit synchronous |
| 25 | All data circuit asynchronous |
| 26 | All dedicated packet access |
| 27 | All dedicated PAD access |

The no reply condition timer (T), is only used for SC = 002, 004 or 61.

19.11.3 Call barring

| | |
|-----------------------------------|----------------------------------|
| *SC*Password# or *SC*Password*BS# | Activate |
| *#SC# or **SC**BS# | Check status |
| #SC*Password# or #SC*Password*BS# | Deactivate |
| **03*330*OLDPWD*NEWPWD*NEWPWD# | Change password for call barring |
| **03**OLDPWD*NEWPWD*NEWPWD# | |
| *03*330*OLDPWD*NEWPWD*NEWPWD# | |
| *03**OLDPWD*NEWPWD*NEWPWD# | |

The Service codes (SC) are the followings:

| | |
|-----|--|
| 33 | call barring of outgoing call |
| 330 | all barring service (only for deactivation) |
| 331 | call barring of outgoing international call |
| 332 | call barring of outgoing international calls except to HPLMN |
| 333 | all outgoing barring service (only for deactivation) |
| 35 | call barring of incoming calls |
| 351 | call barring of incoming calls if roaming |
| 353 | all incoming barring service (only for deactivation) |

The Network service codes (BS) are the same as these of the call forwarding sequences.

19.11.4 Call waiting

| | |
|-------|--------------|
| *43# | Activate |
| *#43# | Check status |
| #43# | Deactivate |

19.11.5 Number presentation

| | |
|-----------------|--------------------------------|
| *#30# | CLIP check status |
| *#31# | CLIR check status |
| *31#PhoneNumber | Invoke CLIR for a voice call |
| #31#PhoneNumber | Suppress CLIR for a voice call |
| *#76# | COLP check status |

19.12 Operator names

| Country Initials | MCC | MNC | Preferred Presentation of Country Initials and Mobile Network Name | Abbreviated Mobile Network Name |
|------------------|-----|-----|--|---------------------------------|
| A | 232 | 01 | A1 | A1 |
| A | 232 | 03 | A max. | max. |
| A | 232 | 05 | one | one |
| A | 232 | 07 | A tele.ring | telering |
| AL | 276 | 01 | AMC-AL | A M C |
| ALG | 603 | 01 | ALG RAMN | AMN |
| AN | 344 | 30 | APUA PCS ANTIGUA | APUA-PCS |
| AND | 213 | 03 | STA-MOBILAND | M-AND |
| AUS | 505 | 01 | Telstra MNet | Telstra |
| AUS | 505 | 02 | YES OPTUS | Optus |
| AUS | 505 | 03 | VODAFONE AUS | VFONE |
| AUS | 505 | 08 | One.Tel | One.Tel |
| AZE | 400 | 01 | AZE-AZERCELL | ACELL |
| AZE | 400 | 02 | AZE RBKCELL | BKCELL |
| B | 206 | 01 | BEL PROXIMUS | PROXI |
| B | 206 | 10 | B mobistar | mobi* |
| BD | 470 | 03 | SHEBA | SHEBA |
| BE | 206 | 20 | Orange | Orange |
| BG | 284 | 01 | M-TEL GSM BG | M-TEL |
| BGD | 470 | 01 | BGD-GP | GP |
| BGD | 470 | 02 | BGD AKTEL | AKTEL |
| BHR | 426 | 01 | BHR M-PLUS | M.PLUS |
| BIH | 218 | 03 | BIH-ERONET | ERONET |
| BIH | 218 | 05 | GSM-MS1 | GSM-MS1 |
| BIH | 218 | 90 | PTT-GSMBIH | BHGSM |
| BRU | 528 | 11 | BRU-DSTCom | DSTCom |
| BW | 276 | 00 | BW MASCOM | MASCOM |
| BW | 652 | 01 | BW MASCOM | MASCOM |
| BY | 257 | 01 | BY VELCOM | VELCOM |
| CAN | 302 | 37 | CAN-MCELL | MCELL |
| CH | 228 | 01 | SWISS GSM | SWISS |
| CH | 228 | 02 | diAx Swiss | diAx |
| CH | 228 | 03 | orange CH | orange |
| CHN | 460 | 00 | CMCC | CMCC |
| CHN | 460 | 01 | CHN-CUGSM | CU-GSM |
| CHU | 466 | 92 | Chunghwa | CHGHWA |
| CI | 612 | 03 | CI Ivoiris | Ivoir |
| CI | 612 | 05 | TELECEL-CI | TELCEL |
| CI | 730 | 01 | CI FNTFI PCS | FNTFI |

| | | | | |
|-----|-----|----|--------------|---------|
| CL | 730 | 10 | CL ENTEL PCS | ENTEL |
| CMR | 624 | 02 | Mobilis | CAM 02 |
| CPV | 625 | 01 | CPV MOVEL | CMOVEL |
| CY | 280 | 01 | CY CYTAGSM | CY-GSM |
| CZ | 230 | 01 | CZ PAEGAS | PAEGAS |
| CZ | 230 | 02 | EUROTEL - CZ | ET - CZ |
| D | 262 | 01 | D1-TELEKOM | T-D1 |
| D | 262 | 02 | D2 PRIVAT | D2 |
| D | 262 | 03 | E-Plus | E-Plus |
| D | 262 | 07 | D Interkom | Ik |
| DK | 238 | 01 | DK TDK-MOBIL | TD MOB |
| DK | 238 | 02 | DK SONOFON | SONO |
| DK | 238 | 20 | TELIA DK | TELIA |
| DK | 238 | 30 | DK Mobilix | #mbix |
| DO | 370 | 01 | orange | orange |
| E | 214 | 01 | E AIRTEL | AIRTL |
| E | 214 | 02 | MOVISTAR | MSTAR |
| E | 214 | 03 | E AMENA | AMENA |
| E | 214 | 07 | MOVISTAR | MSTAR |
| EE | 248 | 01 | EE EMT GSM | EMT |
| EE | 248 | 02 | EE RLE | RLE |
| EE | 248 | 03 | EE Q GSM | Q GSM |
| EGY | 602 | 01 | EGY MobiNiL | MobiNiL |
| EGY | 602 | 02 | EGY CLICK | CLICK |
| ETH | 636 | 01 | ETH-MTN | ET-MTN |
| F | 208 | 01 | Orange F | Orange |
| F | 208 | 10 | F SFR | SFR |
| F | 208 | 20 | BOUYGTEL | BYTEL |
| F | 340 | 01 | F AMERIS | AMERIS |
| F | 547 | 20 | F-VINI | VINI |
| F | 647 | 10 | SFR REUNION | SFR RU |
| FI | 244 | 03 | FI TELIA | TELIA |
| FI | 244 | 05 | FI RL | RL |
| FI | 244 | 09 | FI FINNET | FINNET |
| FI | 244 | 91 | FI SONERA | SONERA |
| FIJ | 542 | 01 | VODAFONE FIJ | VODAFJ |
| GEO | 282 | 01 | GEO-GEOCELL | GCELL |
| GEO | 282 | 02 | MAGTI-GEO | MAGTI |
| GH | 620 | 01 | GH SPACEFON | SPACE |
| GH | 620 | 02 | GH GTGSM | GTGSM |
| GIB | 266 | 01 | GIBTEL GSM | GIBTEL |
| GN | 611 | 02 | GN LAGUI | LAGUI |
| GR | 202 | 01 | GR COSMOTE | C-OTE |
| GR | 202 | 05 | GR PANAFON | PAN |
| GR | 202 | 10 | GR TFI ESTET | TI STET |

| | | | | |
|-----|-----|----|---------------|------------|
| H | 216 | 01 | H PANNON GSM | PANNON |
| H | 216 | 30 | H-WESTEL 900 | W-900 |
| H | 216 | 70 | Vodafone | H-70 |
| HK | 454 | 00 | CSL | CSL |
| HK | 454 | 04 | HK Orange | ORANGE |
| HK | 454 | 06 | HK SMC | HKSMC |
| HK | 454 | 10 | NEW WORLD | NWPCS |
| HK | 454 | 12 | PEOPLES | PEOPLES |
| HK | 454 | 16 | SUNDAY | SUNDAY |
| HR | 219 | 01 | HR-CRONET | CRON |
| HR | 219 | 10 | HR-VIPNET | VIP |
| I | 222 | 01 | I TIM | TIM |
| I | 222 | 10 | I OMNITEL | OMNI |
| I | 222 | 88 | I WIND | I WIND |
| I | 222 | 98 | I BLU | BLU |
| IL | 425 | 01 | IL ORANGE | ORANGE |
| INA | 404 | 01 | ESSARH | ESSARH |
| INA | 404 | 07 | INA TATA | TATA |
| INA | 404 | 10 | INA-AIRTL | AIRTL |
| INA | 404 | 11 | INA ESSAR | ESSAR |
| INA | 404 | 12 | INA - ESCOTEL | ESCOTL |
| INA | 404 | 14 | MODICOM INA | MODICO |
| INA | 404 | 15 | ESSARU | ESSARU |
| INA | 404 | 20 | INA MaxTouch | MAXTCH |
| INA | 404 | 21 | BPL MOBILE | BPL MOBILE |
| INA | 404 | 27 | BPL MOBILE | BPL MOBILE |
| INA | 404 | 30 | INA COMMAND | COMMND |
| INA | 404 | 41 | INA RPG | RPG |
| INA | 404 | 42 | INA AIRCEL | AIRCEL |
| INA | 404 | 43 | BPL MOBILE | BPL MOB |
| INA | 404 | 46 | BPL MOBILE | BPL MOB |
| INA | 404 | 60 | ESSARR | ESSARR |
| IND | 404 | 44 | IN-44 | SPICE |
| IND | 510 | 01 | IND SAT-C | SAT-C |
| IND | 510 | 10 | IND RT-SEL | T-SEL |
| IND | 510 | 11 | IND GSM-XL | EXCEL |
| IRL | 272 | 01 | IRL Eircell | Eircell |
| IRL | 272 | 02 | IRL DIGIFONE | DIGI |
| IS | 274 | 01 | IS SIMINN | SIMINN |
| IS | 274 | 02 | IS TAL | TAL |
| JOR | 416 | 01 | Fastlink | FSTLNK |
| KGZ | 437 | 01 | BITEL KGZ | BITEL |
| KHM | 456 | 01 | MOBITEL-KHM | MT-KHM |
| KHM | 456 | 02 | KHM-SM | KHM-SM |
| KSA | 420 | 01 | AI JAWWAI | KSA |

| | | | | |
|-----|-----|----|--------------|----------|
| KSA | 420 | 07 | EAE-ALJAWWAL | EAE |
| KT | 419 | 02 | KT MTCNet | MTC |
| KT | 419 | 03 | KT WATANIYA | WATANIYA |
| KZ | 401 | 01 | KZ K-MOBILE | K-MOBILE |
| KZ | 401 | 02 | KZ KCELL | KCELL |
| L | 270 | 01 | L LUXGSM | LUXGSM |
| L | 270 | 77 | L TANGO | TANGO |
| LAO | 457 | 01 | LAO GSM | LAO GSM |
| LBR | 618 | 01 | LBR OMEGA | OMEGA |
| LSO | 651 | 01 | VCL COMMS | VCLCOM |
| LT | 246 | 02 | LT BITE GSM | BITE |
| LTU | 246 | 01 | OMNITEL LT | OMT |
| LV | 247 | 01 | LV LMT GSM | LMT |
| LV | 247 | 02 | LV BALTCOM | B-COM |
| M | 278 | 01 | VODAFONE MLA | VODA M |
| MAC | 455 | 01 | MAC-CTMGSM | CTMGSM |
| MD | 259 | 01 | MD VOXTEL | VOXTEL |
| MDG | 642 | 02 | MDG-ANTARIS | ANTARI |
| MKD | 294 | 01 | MKD-MOBIMAK | MOBI-M |
| MOR | 604 | 00 | Meditel | MEDITEL |
| MOR | 604 | 01 | MOR IAM | IAM |
| MOZ | 643 | 01 | MOZ-mCel | mCel |
| MRU | 617 | 01 | CELLPLUS-MRU | CELL + |
| MRU | 617 | 10 | EMTEL-MRU | EMTEL |
| MV | 472 | 01 | MV DHIMOBILE | D-MOBILE |
| MW | 650 | 01 | MW CP 900 | CP 900 |
| MW | 650 | 10 | CELTEL MW | CELTEL |
| MY | 502 | 12 | MY Rmaxis | maxis |
| MY | 502 | 13 | TMTOUCH | TMTOUCH |
| MY | 502 | 16 | MY DIGI 1800 | MT18 |
| MY | 502 | 17 | MY-ADAM 017 | ADAM |
| MY | 502 | 19 | MY CELCOM | CELCOM |
| N | 242 | 01 | N Telenor | TELENOR |
| N | 242 | 02 | N NetCom GSM | N COM |
| NCL | 546 | 01 | NCL MOBILIS | MOBNCL |
| NL | 204 | 04 | NL LIBERTEL | LIBTEL |
| NL | 204 | 08 | NL KPN | NL KPN |
| NL | 204 | 12 | NL TELFORT | TELFORT |
| NL | 204 | 16 | Ben NL | Ben NL |
| NL | 204 | 20 | Dutchtone | Dtone |
| NZ | 530 | 01 | VODAFONE NZ | VODA |
| OMN | 422 | 02 | OMAN MOBILE | OMAN |
| P | 268 | 01 | P TELECEL | TLCL |
| P | 268 | 03 | P OPTIMUS | OPTIM |
| P | 268 | 06 | P TMN | TMN |

| | | | | |
|-----|-----|----|--------------------|----------|
| PGY | 744 | 01 | HOLA PARAGUAY S.A. | HPGYSA |
| PGY | 744 | 01 | HOLA PARAGUAY S.A. | HPGYSA |
| PH | 515 | 01 | ISLACOM | ISLA |
| PH | 515 | 02 | GLOBE PH | GLOBE |
| PH | 515 | 03 | PH SMART | SMART |
| PL | 260 | 01 | PL-PLUS | PLUS |
| PL | 260 | 02 | PL-ERA GSM | ERAGSM |
| PL | 260 | 03 | PL-IDEA | IDEA |
| PSE | 425 | 05 | JAWWAL-PALESTINE | JAWWAL |
| QAT | 427 | 01 | QAT-QATARNET | Q-NET |
| R | 635 | 10 | R-CELL | RCELL |
| RA | 283 | 01 | RA-ARMGSM | ARMMO1 |
| RL | 415 | 01 | RL Cellis | CLLIS |
| RL | 415 | 03 | RL LibanCell | LibCL |
| RO | 226 | 01 | RO CONNEX | CONNEX |
| RO | 226 | 10 | RO dialog | dialog |
| RUS | 250 | 01 | MTS-RUS | MTS |
| RUS | 250 | 02 | NWGSM RUS | NWGSM |
| RUS | 250 | 05 | SCS RUS | SCS |
| RUS | 250 | 07 | RUS BMT | BMT |
| RUS | 250 | 12 | Far East RUS | FEast |
| RUS | 250 | 13 | KUGSM | KUGSM |
| RUS | 250 | 17 | RUS 17 | ERMAK |
| RUS | 250 | 28 | EXTEL RUS | EXTEL |
| RUS | 250 | 39 | Uraltel | UTL |
| RUS | 250 | 44 | NC-GSM | NC-GSM |
| RUS | 250 | 93 | --- | --- |
| RUS | 250 | 99 | BEE L | Bee Line |
| S | 240 | 01 | TELIA | TELIA |
| S | 240 | 07 | S COMVIQ | IQ |
| S | 240 | 08 | EURO | EURO |
| SA | 655 | 01 | VodaCom-SA | VODA |
| SA | 655 | 10 | MTN-SA | MTN |
| SDN | 634 | 01 | SDN MobiTel | SD-MOB |
| SEZ | 633 | 01 | SEZ SEYCEL | SEYCEL |
| SEZ | 633 | 10 | SEZ AIRTEL | AIRTEL |
| SGP | 525 | 01 | ST-GSM-SGP | STGSM |
| SGP | 525 | 02 | GSM1800 | GSM1800 |
| SGP | 525 | 03 | M1-GSM-SGP | M1-GSM |
| SGP | 525 | 05 | STARHUB-SGP | STARHUB |
| SI | 293 | 40 | SI.MOBIL | SI.MOBIL |
| SI | 293 | 41 | SI SI-GSM | SI-GSM |
| SK | 231 | 01 | SVK GT | SVK GT |
| SK | 231 | 02 | EUROTEL-SK | ET-SK |
| SN | 608 | 01 | SN AI IZF | AI IZF |

| | | | | |
|-----|-----|----|---------------------------|----------|
| SN | 608 | 02 | SENTEL | SENTEL |
| SRI | 413 | 02 | SRI DIALOG | DALOG |
| SRI | 413 | 03 | SRI - CELLTEL | CELLTEL |
| SYR | 417 | 09 | SYR MOB SYR | MOBILE |
| SZ | 653 | 10 | Swazi-MTN | SwaziMTN |
| TG | 615 | 01 | TG-TOGO CELL | TGCELL |
| TH | 520 | 01 | TH AIS GSM | TH AIS |
| TH | 520 | 10 | TH ORANGE | ORANGE |
| TH | 520 | 18 | TH-DTAC | DTAC |
| TH | 520 | 23 | TH-HELLO | HELLO |
| TN | 605 | 02 | TUNISIE TELECOM | TT |
| TR | 286 | 01 | TR RTCELL | TCELL |
| TR | 286 | 02 | TR TELSIM | TELSIM |
| TWN | 466 | 01 | FarEastone | FET |
| TWN | 466 | 06 | TWN TUNTEX | TUNTEX |
| TWN | 466 | 88 | KGT-ONLINE | KGT |
| TWN | 466 | 93 | Mobitai | TW MOB |
| TWN | 466 | 97 | TWN GSM | PCC |
| TWN | 466 | 99 | TransAsia | |
| TZ | 640 | 01 | Tritel-TZ | TRITEL |
| TZ | 640 | 03 | ZANTEL-TZ | ZANTEL |
| UA | 255 | 01 | UA UMC | UMC |
| UA | 255 | 03 | UA-KYIVSTAR | UA-KS |
| UA | 255 | 05 | UA-GOLDEN | UA-GT |
| UAE | 424 | 02 | UAE ETISALAT | ETSLT |
| UG | 641 | 01 | UG CelTel | CELTEL |
| UG | 641 | 10 | MTN-UGANDA | MTN-UG |
| UK | 234 | 10 | BTCELLNET | BTCNET |
| UK | 234 | 15 | UK VODAFONE | VODA |
| UK | 234 | 30 | one2one | ONE2ONE |
| UK | 234 | 33 | ORANGE | ORANGE |
| UK | 234 | 50 | JT GSM | JT GSM |
| UK | 234 | 55 | GSY-TEL | GSY-TEL |
| UK | 234 | 58 | MANX | MANX |
| UKR | 255 | 02 | FLASH-UKR | FLASH |
| USA | 310 | 10 | USA MCI | --- |
| USA | 310 | 11 | USA Wireless 2000 Telepho | WTTCKy |
| USA | 310 | 12 | USA D&E Com | --- |
| USA | 310 | 13 | USA MobileTel | --- |
| USA | 310 | 20 | USA Sprint | --- |
| USA | 310 | 30 | USA PCS PRIME | --- |
| USA | 310 | 31 | USA-AERIAL | AERIAL |
| USA | 310 | 40 | USA PCS PRIME | --- |
| USA | 310 | 50 | USA PCS PRIME | --- |
| USA | 310 | 60 | USA PCS PRIME | --- |

| | | | | |
|-----|-----|-----|---------------------------|---------|
| USA | 310 | 70 | USA PCS PRIME | --- |
| USA | 310 | 80 | USA PCS PRIME | --- |
| USA | 310 | 90 | USA PCS PRIME | --- |
| USA | 310 | 100 | USA PCS PRIME | --- |
| USA | 310 | 110 | USA Wireless 2000 Telepho | WTTCKy |
| USA | 310 | 120 | USA PCS PRIME | --- |
| USA | 310 | 130 | USA PCS PRIME | --- |
| USA | 310 | 140 | USA PCS PRIME | --- |
| USA | 310 | 150 | BellSouth Mobility DCS | BSMDCS |
| USA | 310 | 160 | USA OMNIPOINT | --- |
| USA | 310 | 170 | USA PAC BELL | --- |
| USA | 310 | 180 | USA PAC BELL | --- |
| USA | 310 | 190 | USA COX | --- |
| USA | 310 | 200 | VoiceStream | VStream |
| USA | 310 | 210 | VoiceStream | VStream |
| USA | 310 | 220 | VoiceStream | VStream |
| USA | 310 | 230 | VoiceStream | VStream |
| USA | 310 | 240 | VoiceStream | VStream |
| USA | 310 | 250 | VoiceStream | VStream |
| USA | 310 | 260 | VoiceStream | VStream |
| USA | 310 | 270 | USA Powertel, Inc. | USA27 |
| USA | 310 | 280 | USA PowerTel | --- |
| USA | 310 | 290 | USA PowerTel | --- |
| USA | 310 | 300 | USA Aerial | --- |
| USA | 310 | 310 | USA-AERIAL | AERIAL |
| USA | 310 | 320 | USA Aerial | --- |
| USA | 310 | 330 | USA Aerial | --- |
| USA | 310 | 340 | USA Aerial | --- |
| USA | 310 | 350 | USA Aerial | --- |
| USA | 310 | 380 | USA Pocket | --- |
| USA | 310 | 390 | USA Pocket | --- |
| USA | 310 | 400 | USA Pocket | --- |
| USA | 310 | 410 | USA Pocket | --- |
| USA | 310 | 420 | USA Pocket | --- |
| USA | 310 | 430 | USA Pocket | --- |
| USA | 310 | 440 | USA Pocket | --- |
| USA | 310 | 450 | USA Pocket | --- |
| USA | 310 | 460 | USA OMNIPOINT | --- |
| USA | 310 | 470 | USA OMNIPOINT | --- |
| USA | 310 | 480 | USA OMNIPOINT | --- |
| USA | 310 | 490 | USA OMNIPOINT | --- |
| USA | 310 | 500 | USA OMNIPOINT | --- |
| USA | 310 | 510 | USA OMNIPOINT | --- |
| USA | 310 | 520 | USA OMNIPOINT | --- |
| USA | 310 | 530 | USA OMNIPOINT | --- |

| | | | | |
|-----|-----|-----|-----------------------|---------|
| USA | 310 | 540 | USA OMNIPOINT | --- |
| USA | 310 | 550 | USA OMNIPOINT | --- |
| USA | 310 | 560 | USA OMNIPOINT | --- |
| USA | 310 | 570 | USA OMNIPOINT | --- |
| USA | 310 | 580 | USA OMNIPOINT | --- |
| USA | 310 | 610 | USA OMNIPOINT | --- |
| USA | 310 | 620 | USA OMNIPOINT | --- |
| USA | 310 | 630 | USA OMNIPOINT | --- |
| USA | 310 | 640 | USA Einstein | --- |
| USA | 310 | 660 | USA DiGiPH | --- |
| USA | 310 | 670 | USA WTTCKy | --- |
| USA | 310 | 680 | USA NPI | --- |
| USA | 310 | 690 | USA Conestoga | --- |
| USA | 310 | 770 | Iowa Wireless USA | IWS |
| USA | 310 | 790 | USA PinPoint Wireless | PnPt |
| UZB | 434 | 04 | UZB DAEWOO | DW-GSM |
| UZB | 434 | 05 | UZB COSCOM | COSCOM |
| VN | 452 | 01 | VN Mobi Fone | VMS |
| VN | 452 | 02 | VN VINA FONE | GPC |
| VZ | 734 | 01 | VZ INFO | INFONT |
| VZ | 734 | 02 | DIGITEL | DIGITEL |
| YU | 220 | 01 | YU MOBTEL | MOBTEL |
| ZW | 648 | 01 | ZW NET*ONE | NET*1 |

19.13 Data / Commands multiplexing protocol

19.13.1 Introduction

The Wavecom multiplexing protocol operates between a DCE (Data Communication Equipment: the product) and a DTE (Data Terminal Equipment). It allows a double session over a serial link interface : one for AT commands and one for DATA communications.

AT+WMUX=1 activates the Multiplexing Mode. With this mode, AT commands and DATA are encapsulated into packets. The header of these packets allows to recognize whether it is a DATA packet or an AT command packet. AT+WMUX=0 deactivates the Multiplexing Mode and gets the product back to the default mode.

This appendix presents how the multiplexing mode handles the DATA and the AT commands flow. It also describes the format of DATA packets and AT command packets.

19.13.2 AT command packets

An AT command is encapsulated into a packet with a header which allows to separate it from DATA packets. This packet is formed by a header (3 bytes), the AT command itself and a checksum (1 byte) :

| B7 | B6 | B5 | B4 | B3 | B2 | B1 | B0 |
|---------------------------|----|----|----|----|-----------------------|----|----|
| Start pattern → 0xAA | | | | | | | |
| AT command length LSB | | | | | | | |
| AT command pattern → 0x1D | | | | | AT command length MSB | | |
| AT command | | | | | | | |
| Checksum | | | | | | | |

The 3 bytes of the header are:

- ➔ the first byte (0xAA) is used to identify the packet,
- ➔ the second byte represents the 8 LSB (Low Significant Bits) bits of the length of the AT command,
- ➔ the third byte is made of 2 parts :
 - the 3 LSB bits are the 3 MSB (Most Significant Bits) bits of the length of the AT command,
 - the 5 MSB bits (0x1D which equals to 0xE8 with the 3 bits offset) are used to identify an AT command.

The maximum length of an AT command could be 2047 bytes which is greater than all the existing AT commands.

The checksum is the addition (modulo 256) of all the transmitted bytes (header bytes and AT command bytes).

19.13.3 Data packets

Like for AT commands, DATA are encapsulated into packets. These packets are composed of a header (3 bytes), the data bytes and the checksum (1 byte) :

| B7 | B6 | B5 | B4 | B3 | B2 | B1 | B0 |
|------------------------|----|----|----|----|------------------------|----|----|
| Start pattern → 0xDD | | | | | | | |
| Data packet length LSB | | | | | | | |
| Data packet type | | | | | Data packet length MSB | | |

| |
|------------|
| Data Bytes |
| Checksum |

The 3 bytes of the header are:

- ➔ the first byte (0xDD) used to identify the packet,
- ➔ the second byte represents the 8 LSB bits of the length of the data field,
- ➔ the last byte is made of 2 parts :
 - the 3 LSB bits represent the 3 MSB bits of the length of the data field,
 - the 5 MSB bits represent the packet type.

Data packets can have different values according to the type of packet:

- ➔ 0 – DATA packet : the packet contains the data to transmit on the radio link or received from the radio link,
- ➔ 1 – STATUS packet: the packet contains the status of SA, SB, X bits⁽¹⁾ and the break condition coding as follow :

| | | | | | | | |
|----|----|---|-----|----|-------|-------|-------|
| SA | SB | X | BRK | RI | Spare | Spare | Spare |
|----|----|---|-----|----|-------|-------|-------|

- the length of data for the status packet is always equal to 1,
- whenever a status changes (except break), all the status bits are included,
- these bits are off by default (and therefore the bits DTR and RTS), so it is necessary to send a status packet to the target at the beginning of the multiplexing to start the transmission,
- ➔ 2 – READY packet : the packet indicates that the target is ready to receive data :
 - no data are transmitted in this packet (so the length is null),
- ➔ 3 – BUSY packet : the packet indicates that the target is busy and can not receive data :
 - like the ready packet, no data are transmitted,
- ➔ other values : currently, these values are not used (reserved for future enhancement).

The checksum is calculated like the AT command packet checksum (addition of all the transmitted bytes including the header bytes).

19.13.4 Examples

19.13.4.1 AT command and its answer

When there is no encapsulation the AT command transmitted on the serial link is like this (in ASCII and hexadecimal):

AT\r\n ⇔ 0x41 0x54 0x0D 0x0A

and the answer is like this :

\r\nOK\r\n ⇔ 0x0D 0x0A 0x4F 0x4B 0x0D 0x0A

With the encapsulation in the serial link, the packet transmitted is (in hexadecimal) :

0xAA 0x04 0xE8 0x41 0x54 0x0D 0x0A 0x42

and the answer is like this :

0xAA 0x06 0xE8 0x0D 0x0A 0x4F 0x4B 0x0D 0x0A 0x60

¹ These status bits contain the V24 control information :

- SA contains DTR (signal CT108 – from terminal to IWF) and DSR (signal CT107 – from terminal to IWF),
- SB contains RTS (signal CT105 – from terminal to IWF) and DCD (signal CT109 – from IWF to terminal),
- X contains CTS (signal CT106).

For more information, refer to GSM 07.02

19.13.4.2 Initialisation and Data packet

When the Multiplexing Mode is activated (+WMUX=1), the product sends 2 Data packets after the establishment of a DATA call (after the CONNECT xxxx message) : 1 READY Packet and 1 STATUS Packet. To set the different signals to the right value, it is necessary to send a STATUS packet to the product.

Here are some examples of STATUS packets :

0xDD 0x01 0x08 0x40 0x26 ⇔ bit RTS is on

to start a data call, all the bits should be on :

0xDD 0x01 0x08 0xC0 0xA6 ⇔ bits DTR and RTS are on

19.13.5 Restriction

The autobauding mode is not available when the Multiplexing Mode is activated : the serial link speed must be set to a fixed rate.

20 APPENDIX A (informative)

This chapter gives illustrative examples of the general AT commands used for a communication.

20.1 Examples with the PIN required

Example 1 : when the ME is powered off.

```

AT+CMEE=1          Enable the report mobile equipment errors
OK
AT+CREG=1          Report registration
OK
AT+CPAS            Query ME Status
+CPAS: 5          (ME is asleep)
OK
AT+CFUN=1          Set ME to full functionality
OK
AT+COPS=0          Ask for automatic operator selection and registration.
+CME ERROR: 11    SIM PIN required.
AT+CPIN=1234       User entered a wrong PIN
+CME ERROR: 16    Incorrect password.
AT+CPIN=0000
OK                PIN Ok
AT+COPS=0          Ask for automatic operator selection and registration.
OK
+CREG:1           Registered on the network
AT+COPS=3,0        Select the long name alphanumeric format.
OK
AT+CPIN?           Get the operator name
+CPIN: 0,0,"I OMNITEL"
OK
  
```

Example 2: When the ME has already been powered on.

```

AT+CMEE=1          Enable the report mobile equipment errors
OK
AT+CPAS            Get the ME Status
+CPAS: 0          ME is ready to receive commands
OK
AT+CPIN?           Is ME requiring a password?
+CPIN: SIM PIN    Yes, SIM PIN required
AT+CPIN=0000
OK                PIN Ok
  
```

20.1.1 Examples where a voice call is originated.

Example 3 : When the ME is powered on and the SIM PIN has been entered.

```

AT+CMEE=1          Enable the reporting of mobile equipment errors
OK
AT+WIND=63         Ask to display the general indications.
OK
AT+CPIN?           Is ME requiring a password?
+CPIN: READY       product is ready
ATD0607103543;     Make a voice call
+WIND: 5,1         Indication of call
+WIND: 2           Remote party is ringing.
OK                Call setup was successful
Conversation...
ATH                Release the call
OK
  
```

When a voice call is attempted from a phonebook :

```

ATD>"John Pamborn";
+CME ERROR: 22      The "John Pamborn" entry is not found.
ATD>"Joel Guerry";
+WIND: 5,1          Indication of outgoing call.
+WIND: 2            Remote party is ringing.
OK                  Call setup was successful
Conversation...
ATH                  Release the call
OK
    
```

20.1.2 Example with incoming calls

When the ME is powered on and the SIM PIN has been entered.

```

AT+CMEE=1           Enable the report mobile equipment errors
OK
AT+WIND=63          Ask to display the general indications.
OK
AT+CLIP=1           Enable the calling line identification presentation.
OK
AT+CRC=1            Enable extended format of incoming indication.
OK
AT+CNUM             Query own number (voice number) or MSISDN.
+CNUM: "Speech", "+33608971019",145
OK
Call the number from another ME.
+WIND: 5, 1         Indication of call (Ring)
+CRING: VOICE       Type of call is VOICE.
+CLIP: "+33607103543",145,,,"John Panborn"  Identification of the remote party.
+CRING: VOICE
ATA                  Answer the call.
OK
...Conversation...
NO CARRIER         The call has been released by the remote party.
+WIND: 6,1          Indication of call release.
    
```

20.1.3 Example of a call forwarding

When the ME is powered on and the SIM PIN has been entered.

```

AT+CMEE=1           Enable the report mobile equipment errors
OK
AT+CFCC=1,3,"0607492638" Register to a call forwarding when ME is busy.
OK
AT+CCFC=2,3,"0149293031",129 Register to a call forwarding when it does answer.
+CME ERROR: 30      No network service
AT+CCFC=1,2         Interrogate
+CCFC: 1,1,"+33607492638",145 Call forwarding active for a voice call.
AT+CFCC=1,4         Delete call forwarding ME busy
OK
    
```

20.1.4 Example of a multiparty call

When the ME is powered on and the SIM PIN has been entered.

```

AT+CMEE=1          Enable the report mobile equipment errors
OK
AT+WIND=63         Ask to display the general indications.
OK
AT+CCWA=1,1       Enable call waiting.
OK
ATD>"John Panborn";
+WIND: 5,1        Indication of call.
+WIND: 2          Remote party is ringing.
OK               Call setup was successful
...Conversation...
+WIND: 5,2        Indication of another call.
+CCWA: "+33595984834",145,"Dolores Claiborne"  Another call is waiting.
AT+CHLD=2         Put first call on hold and answer the second one.
OK
...Conversation...
AT+CHLD=3         Every call is part of a multiparty conversation.
OK
AT+CHLD=11       Release the first call (with John Panborn) and recover the second call
(with Dolores Claiborne)
...Conversation ...
ATH              Release the second call.
  
```

20.2 Examples about phonebooks

For each example illustrated in this section: at the beginning the ME is powered on and the SIM PIN has been entered.

20.2.1 Example 1 : The whole phonebook of the ME is read

```

AT+CPBS=?         Query supported phonebook memories
+CPBS: ("SM","FD","ON")  ADN, FDN, and MSISDN phonebooks supported.
AT+CPBS="SM"      Select ADN phonebook..
OK
AT+CPBR=?         Read the index range and the length of the elements.
+CPBR: (1-80),20,14  80 locations (from 1 to 80), max length of 20 for the phone
number, 14 characters max for the text.
AT+CPBR=1,80     Read all entries (only the ones set are returned).
+CPBR: 1,"0346572834",129,"Dolores Claiborne"
+CPBR: 2,"1284374523",129,"Thad Beaumont"
+CPBR: 3, "1243657845",129,"John Panborn"
OK
  
```

20.2.2 Example 2 : Erase or Write a phonebook entry

```

AT+CPBW=?         Get the phonebook type.
+CPBW: (1-80),20,(129,145),14  80 locations, max length of 20 for the phone number,
TON/NPI of 129 or 145 and 14 characters max for the text.
AT+CPBW=3        Erase location 3
OK
AT+CPBW=3,"4356729012",129,"Carry"  Write at location 3.
Ok
AT+CPBR=1,80     Read all entries (only the ones set are returned).
+CPBR: 1,"0346572834",129,"Dolores Claiborne"
+CPBR: 2,"1284374523",129,"Thad Beaumont"
+CPBR: 3,"4356729012",129,"Carry"
OK
  
```

OK
AT+CMGS=0601290800 Send a SMS-SUBMIT to mobile phone
Product sends a 4 characters sequence: 0x0D 0x0A 0x3E 0x20
This is the first text line Edit first line and press carriage return (<CR>, 0x0D)
This is the last text line Edit last line and send message by pressing <ctrl-Z> (0x1A)
+CMGS: 5 Success: message reference 5 is returned from the SMS Service Center
+CDS: 2,5,"0601290800",129,"99/05/01 14:15:10+04
" " " " Success: report of successful message delivery received

20.3.2 Example 5: Read short messages

AT+CMGF=1 Text mode to read Short Messages

AT+CMGL="ALL" List all stored messages
+CMGL: 1,"REC READ","+336290918",,"99/05/01 14:15:10+04"
This is the first message
+CMGL: 2,"REC UNREAD","+336290918",,"99/05/01 14:19:44+04"
This is the second message

OK
AT+CMGR=1 " " Read the first message
+CMGR: "REC READ","+336290918",,"99/05/01 14:19:44+04"
OK

20.4 Examples about Fax class 2

The normal characters are generated DTE. The bold characters are modem generated.

20.4.1 Example 1 : Send a fax class 2

AT+FCLASS=2 Select fax class 2
OK
AT+FLID="LocalFax"
OK
ATD0601234567 Call establishment
+FCON Connection OK
[+FCSI:"RemoteFax"]
+FDIS:0,3,0,2,0,0,0
OK
AT+FDT Beginning of the data transfer
+FDCS:0,3,0,2,0,0,0
CONNECT
<0x11h> Send carrier
First page data terminated by <0x10h><0x03h>
OK Page transmitted
AT+FET=0 Send another page
+FPTS:1 First page acquitted
OK
AT+FDT
CONNECT
<0x11h> Send carrier
Second page data terminated by <0x10h><0x03h>
OK Page transmitted
AT+FET=2 No more page
+FPTS:1 First page acknowledged
+FHNG:0 Normal end of connection
OK

20.4.2 Example 2: Receive a fax class 2

```
AT+FCR=1
OK
AT+FLID="LocalFax"
OK
RING                               Incoming call
ATA                                 Answer
+FCON                               Connection OK
[+FTSI:"RemoteFax"]
+FDCS:0,3,0,2,0,0,0,0
OK
AT+FDR
+FCFR
+FDCS:0,3,0,2,0,0,0,0
CONNECT
<0x12h>                             Receive page carrier
First page data terminated by
<0x10h><0x03h>
OK                                 Page received
+FPTS:1                             First page acknowledged
+FET:0                               To receive another page
OK
AT+FDR
+FDCS:0,3,0,2,0,0,0,0
CONNECT
<0x12h>                             Receive page carrier

Second page data terminated by
<0x10h><0x03h>
OK                                 Page received
+FPTS:1                             First page acknowledged
+FET:2                               No more page to receive
OK
AT+FDR
+FHNG:0                             Normal end of connection
OK
```

21 APPENDIX B: Support of SIM ToolKit by The M.E.

TABLE 1 – Support of SIM Toolkit classes

This has been extracted from the 11.14.

| Command description | Classes | | |
|--|---------|---|----|
| | 1 | 2 | 3 |
| CALL CONTROL | | X | X |
| CELL BROADCAST DOWNLOAD | | X | X |
| DISPLAY TEXT | | X | X |
| EVENT DOWNLOAD | | | |
| - MT call | | | X |
| - Call connected | | | X |
| - Call disconnected | | | X |
| - Location status | | | X |
| - User activity | | | X |
| - Idle screen available | | | X |
| GET INKEY | | X | X |
| GET INPUT | | X | X |
| GET READER STATUS \$(MultipleCard)\$ | | | Lc |
| MENU SELECTION | | X | X |
| MO SHORT MESSAGE CONTROL | | | X |
| MORE TIME | | X | X |
| PERFORM CARD APDU \$(MultipleCard)\$ | | | Lc |
| PLAY TONE | | X | X |
| POLLING OFF | | X | X |
| POLL INTERVAL | | X | X |
| POWER ON CARD \$(MultipleCard)\$ | | | Lc |
| POWER OFF CARD \$(MultipleCard)\$ | | | Lc |
| PROVIDE LOCAL INFORMATION | | X | X |
| REFRESH | X | X | X |
| RUN AT COMMAND \$(AT\$) | | | Lc |
| SELECT ITEM | | X | X |
| SEND SHORT MESSAGE | | X | X |
| SEND SS | | X | X |
| SEND USSD | | | X |
| SET UP CALL | | X | X |
| SET UP EVENT LIST | | | X |
| SET UP IDLE MODE TEXT \$(IdleModeText)\$ | | | X |
| SET UP MENU | | X | X |
| SMS-PP DOWNLOAD | X | X | X |
| TIMER MANAGEMENT \$(Timer)\$ | | | Lc |
| TIMER EXPIRATION \$(Timer)\$ | | | Lc |

TABLE 2 - Compatibility between available Terminal Responses and Proactive Commands

| Terminal Responses | Proactive commands | | | | | | | | | | | |
|---|--------------------|-----------------|---------------|---------------|----------------|---------------|-----------------|-------------|-------------|--------------|----------------|-----------------------|
| | Setup Menu (0) | Display Text(1) | Get Inkey (2) | Get Input (3) | Setup Call (4) | Play Tone (5) | Select Item (6) | Refresh (7) | Send SS (8) | Send SMS (9) | Send USSD (10) | Setup event list (11) |
| Backward Move (95) | | • | • | • | | | • | | | | | |
| Command beyond ME capabilities (96) | • | • | • | • | • | • | • | • | • | • | • | • |
| ME currently unable to process command (97) | • | • | • | • | • | • | • | • | • | • | • | • |
| No response from the user (98) | | • | • | • | | | • | | | | | |
| SIM session terminated by the user (99) | | • | • | • | • | • | • | | | | | |

22 APPENDIX C: Structure of TERMINAL PROFILE

First byte (Download):

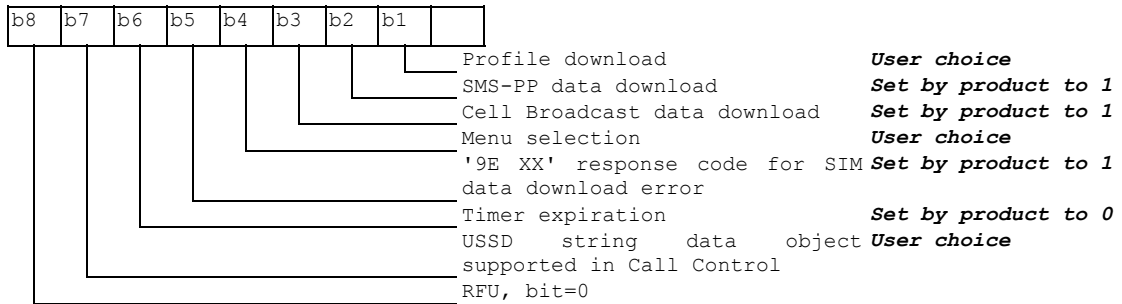

Second byte (Other):

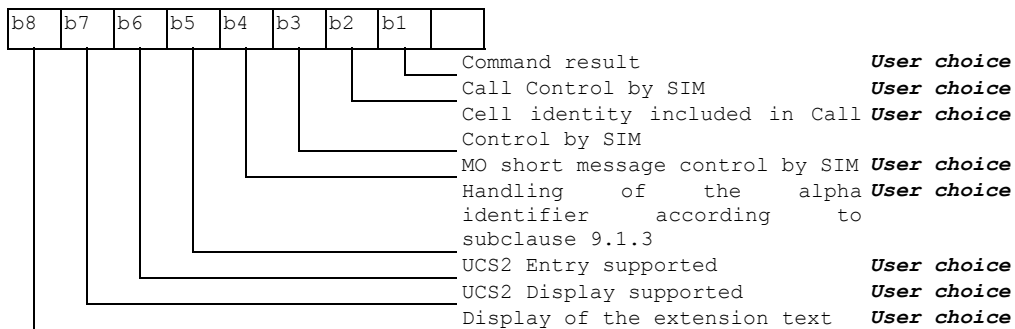

Third byte (Proactive SIM):

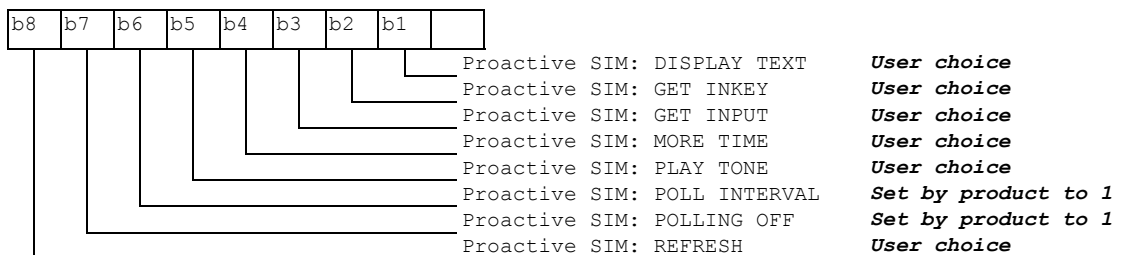

Fourth byte (Proactive SIM):

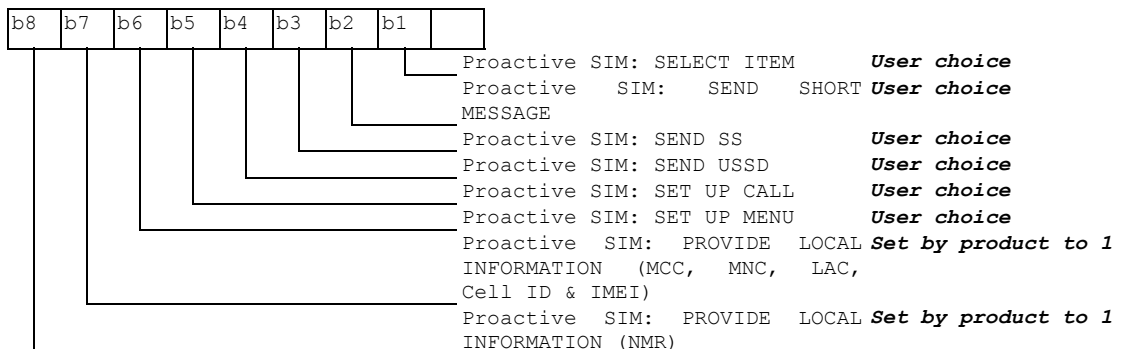

Fifth byte (Event driven information):

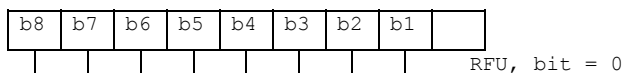
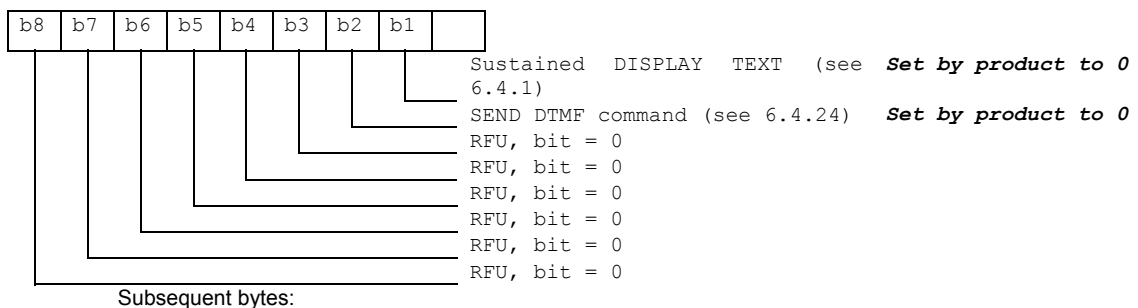
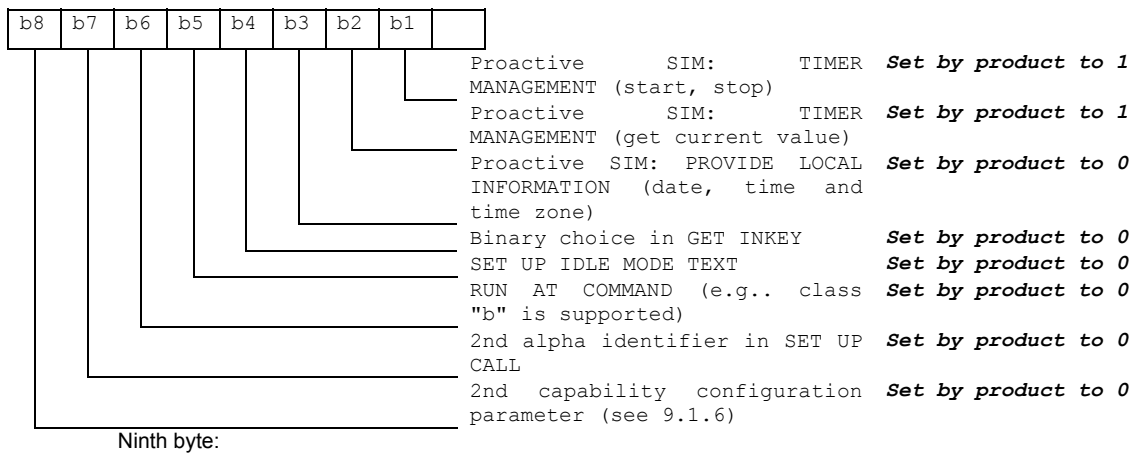
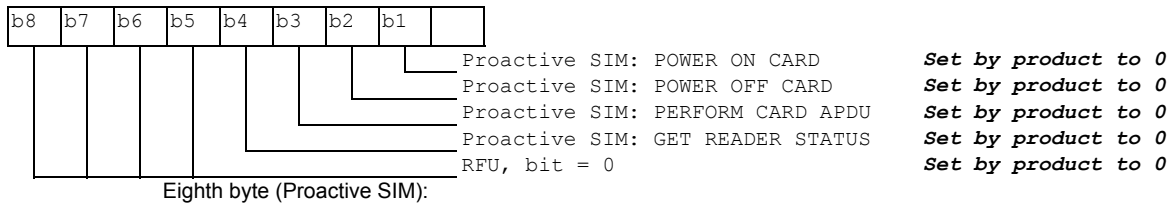
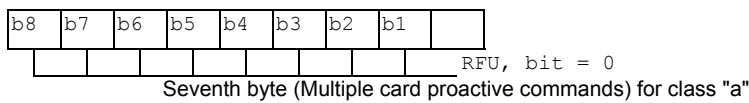
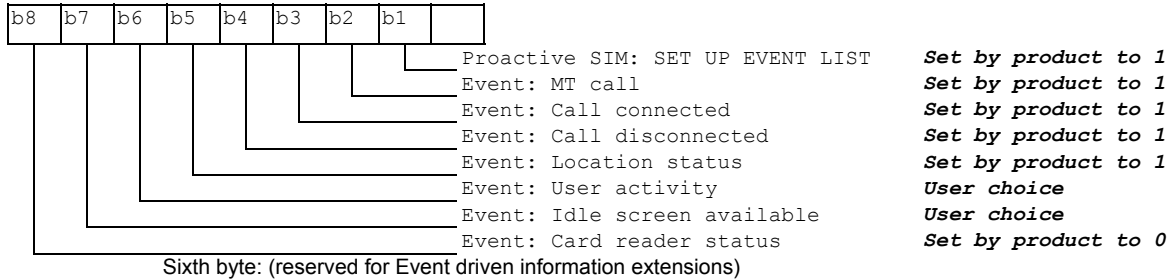

23 APPENDIX D: Command Type and Next Action Indicator.

This table has been extracted from the 11.14.

| Value | Name | Used for Type of Command coding | used for Next Action Indicator coding |
|-------|------------------------------|---------------------------------|---------------------------------------|
| '00' | | - | - |
| '01' | REFRESH | X | |
| '02' | MORE TIME | X | |
| '03' | POLL INTERVAL | X | |
| '04' | POLLING OFF | X | |
| '05' | SET UP EVENT LIST | X | |
| '10' | SET UP CALL | X | X |
| '11' | SEND SS | X | X |
| '12' | SEND USSD | X | X |
| '13' | SEND SHORT MESSAGE | X | X |
| '14' | SEND DTMF | X | |
| '20' | PLAY TONE | X | X |
| '21' | DISPLAY TEXT | X | X |
| '22' | GET INKEY | X | X |
| '23' | GET INPUT | X | X |
| '24' | SELECT ITEM | X | X |
| '25' | SET UP MENU | X | X |
| '26' | PROVIDE LOCAL INFORMATION | X | |
| '27' | TIMER MANAGEMENT | X | |
| '28' | SET UP IDLE MODEL TEXT | X | X |
| '30' | PERFORM CARD APDU | class "a" only X | X |
| '31' | POWER ON CARD | class "a" only X | X |
| '32' | POWER OFF CARD | class "a" only X | X |
| '33' | GET READER STATUS | class "a" only X | X |
| '34' | RUN AT COMMAND | class "b" only X | |
| '81' | End of the proactive session | not applicable | X |

24 APPENDIX E: Coding of Alpha fields in the SIM for UCS2

The coding can take one of the three following structures. If the ME supports UCS2 coding of alpha fields in the SIM, the ME shall support all three coding schemes for character sets containing 128 characters or less; for character sets containing more than 128 characters, the ME shall at least support the first coding scheme. If the alpha field record contains GSM default alphabet characters only, then none of these schemes shall be used in that record. Within a record, only one coding scheme, either GSM default alphabet, or one of the three described below, shall be used.

- 1) If the **first octet in the alpha string is '80'**, then the remaining octets are 16 bit UCS2 characters, with the more significant octet (MSO) of the UCS2 character coded in the lower numbered octet of the alpha field, and the less significant octet (LSO) of the UCS2 character is coded in the higher numbered alpha field octet, e.g.. octet 2 of the alpha field contains the more significant octet (MSO) of the first UCS2 character, and octet 3 of the alpha field contains the less significant octet (LSO) of the first UCS2 character (as shown below). Unused octets shall be set to 'FF', and if the alpha field is an even number of octets in length, then the last (unusable) octet shall be set to 'FF'.

Example 1

| Octet 1 | Octet 2 | Octet 3 | Octet 4 | Octet 5 | Octet 6 | Octet 7 | Octet 8 | Octet 9 |
|---------|--------------------|--------------------|--------------------|--------------------|--------------------|--------------------|---------|---------|
| '80' | Ch1 _{MSO} | Ch1 _{LSO} | Ch2 _{MSO} | Ch2 _{LSO} | Ch3 _{MSO} | Ch3 _{LSO} | 'FF' | 'FF' |

- 2) If the **first octet of the alpha string is set to '81'**, then the second octet contains a value indicating the number of characters in the string, and the third octet contains an 8 bit number which defines bits 15 to 8 of a 16 bit base pointer, where bit 16 is set to zero, and bits 7 to 1 are also set to zero. These sixteen bits constitute a base pointer to a "half-page" in the UCS2 code space, to be used with some or all of the remaining octets in the string. The fourth and subsequent octets in the string contain codings as follows; if bit 8 of the octet is set to zero, the remaining 7 bits of the octet contain a GSM Default Alphabet character, whereas if bit 8 of the octet is set to one, then the remaining seven bits are an offset value added to the 16 bit base pointer defined earlier, and the resultant 16 bit value is a UCS2 code point, and completely defines a UCS2 character.

Example 2

| Octet 1 | Octet 2 | Octet 3 | Octet 4 | Octet 5 | Octet 6 | Octet 7 | Octet 8 | Octet 9 |
|---------|---------|---------|---------|---------|---------|---------|---------|---------|
| '81' | '05' | '13' | '53' | '95' | 'A6' | 'XX' | 'FF' | 'FF' |

In the above example;

- Octet 2 indicates there are 5 characters in the string
- Octet 3 indicates bits 15 to 8 of the base pointer, and indicates a bit pattern of 0hhh hhhh h000 0000 as the 16 bit base pointer number. Bengali characters for example start at code position 0980 (*0000 1001 1000 0000*), which is indicated by the coding '13' in octet 3 (shown by the italicised digits).
- Octet 4 indicates GSM Default Alphabet character '53', e.g.. "S".

- Octet 5 indicates a UCS2 character offset to the base pointer of '15', expressed in binary as follows 001 0101, which, when added to the base pointer value results in a sixteen bit value of 0000 1001 1001 0101, e.g.. '0995', which is the Bengali letter KA.

Octet 8 contains the value 'FF', but as the string length is 5, this a valid character in the string, where the bit pattern 111 1111 is added to the base pointer, yielding a sixteen bit value of 0000 1001 1111 1111 for the UCS2 character (e.g.. '09FF').

- 3) **If the first octet of the alpha string is set to '82'**, then the second octet contains a value indicating the number of characters in the string, and the third and fourth octets contain a 16 bit number which defines the complete 16 bit base pointer to a "half-page" in the UCS2 code space, for use with some or all of the remaining octets in the string. The fifth and subsequent octets in the string contain coding as follows; if bit 8 of the octet is set to zero, the remaining 7 bits of the octet contain a GSM Default Alphabet character, whereas if bit 8 of the octet is set to one, the remaining seven bits are an offset value added to the base pointer defined in octets three and four, and the resultant 16 bit value is a UCS2 code point, and defines a UCS2 character.

Example 3

| Octet 1 | Octet 2 | Octet 3 | Octet 4 | Octet 5 | Octet 6 | Octet 7 | Octet 8 | Octet 9 |
|---------|---------|---------|---------|---------|---------|---------|---------|---------|
| '82' | '05' | '05' | '30' | '2D' | '82' | 'D3' | '2D' | '31' |

In the above example

- Octet 2 indicates there are 5 characters in the string
- Octets 3 and 4 contain a sixteen bit base pointer number of '0530', pointing to the first character of the Armenian character set.
- Octet 5 contains a GSM Default Alphabet character of '2D', which is a dash "-".
- Octet 6 contains a value '82', which indicates it is an offset of '02' added to the base pointer, resulting in a UCS2 character code of '0532', which represents Armenian character Capital BEN.
- Octet 7 contains a value 'D3', an offset of '53', which when added to the base pointer results in a UCS2 code point of '0583', representing Armenian Character small PIWR.

25 APPENDIX F: Specification of Power Down Control via RS232

This appendix aims at describing how the power down mode of the product can be activated and deactivated via the RS232 serial link. Refer to +W32K to activate or deactivate the power down mode.

In this document, the term "DTE" refers to the customer device driving the product, which is referred to as the "DCE".

The terms referring to the RS232 signals and levels are used according to recommendations V.24 and V.28. However they are worth at remembering:

DTR is the circuit 108/2, TX is the circuit 103, RX is the circuit 102 and CTS is the circuit 106.

The logical level "HIGH or ON" corresponds to the electrical level of 12 V, whereas the level "LOW or OFF" corresponds to -12 V.

Basically the activation and deactivation is always initiated from the DTE and is carried out through the handshaking of DTR and CTS.

The power down mode can be entered only when the DCE is idle, e.g.. when no connection to the network is in progress.

Into the details :

Whenever the DTE requests the DCE to enter the power down mode, the DTE drops (ON-to-OFF transition) DTR. From this time on, the DTE **must not send** any more characters on the TX line e.g.. even the TX FIFO must be empty.

The DCE acknowledges entry in the power down mode by dropping CTS, which can occur at maximum 5s after the DTR drop. However during that latency period the DTE is prohibited from sending any more AT commands.

AT responses can be sent back to the DTE even if the DCE is in power down mode (actually the DCE exits the power down mode, sends the AT response and enters back the power down mode). Therefore the DTE can drop DTR just after sending an AT command and before receiving the AT response.

The DCE is made to exit the power down mode by raising the DTR. DCE is not ready to receive further AT commands until it raises in turn CTS, which can take up to 2s from the DTR raise.

Here below is a diagram depicting the handshaking:

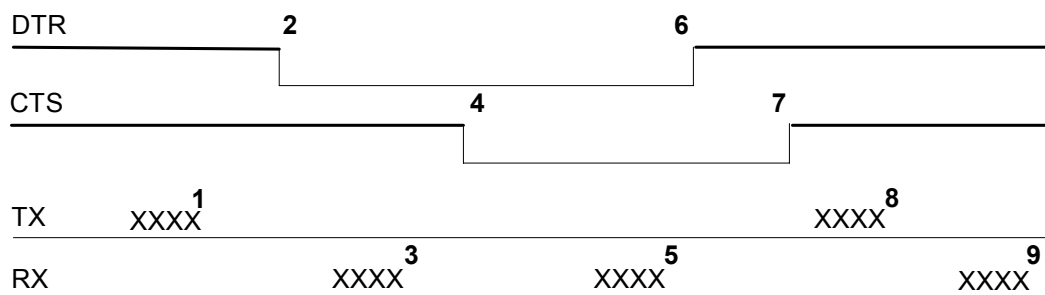

Description of the stages:

1: the DTE sends an AT command

2: the DTE drops DTR to make the DCE enter the power down mode. Warning: this mode will not really enter until CTS is dropped (stage 4). The DTE could also have dropped DTR after receiving the AT response (stage 3).

3: the DCE sends back the AT response (if any)

4: the DCE drops CTS and does enter the power down mode.

5: the DCE sends back an unsolicited response (for instance a RING or +SMTI (incoming SMS indication))

6: the DTE wants to reply to that unsolicited response so it causes the DCE to exit the power down mode by raising its DTR.

7: in turn the DCE acknowledges the exit of the power down mode by raising CTS.

8) & 9) exchange of AT commands/responses.

Note 1): The DTE must not send any AT commands from stage 2 on up to stage 7.

Note 2): During the latency period (between stages 2 and 4) should the DTE want to abort the power down mode, it raises DTR and should wait for 150us before assessing CTS. If CTS is still high than the DCE has aborted the power down mode and is ready to receive AT commands. The 150us wait should get around the race condition between DTR raise and CTS drop.

26 APPENDIX G : Conditions for command execution and dependence to SIM

26.1 General commands

| AT commands | Conditions | SIM dependence | Intermediate |
|-------------|---|--------------------------|--------------|
| AT+CGMI | None | N | N |
| AT+CGMM | None | N | N |
| AT+CGMR | None | N | N |
| AT+CGSN | None | N | N |
| AT+CSCS | +WIND: 4 | N | N |
| AT+WPCS | +WIND: 4 | N | N |
| AT+CIMI | +WIND: 4 | Y | N |
| AT+CCID | +WIND: 1 | Y | N |
| AT+GCAP | None | N | N |
| A/ | Depends on previous command | Depends on prev. command | N |
| AT+CPOF | +WIND: 3 without SIM, +WIND: 1 with SIM | N | N |
| AT+CFUN | None | N | N |
| AT+CPAS | None | N | N |
| AT+CMEE | None | N | N |
| AT+CKPD | Depends of the sequence used | Y/N | N |
| AT+CCLK | +WIND: 4 | Y | N |
| AT+CALA | None | N | Y |
| AT+CRMP | None | N | N |
| AT+CRSL | None | N | N |

26.2 Call Control commands

| AT commands | Conditions | SIM dependence | Intermediate |
|-------------|--------------------------|----------------|--------------|
| ATD | Depends of sequence used | Y/N | Y |
| ATH | None | N | N |
| ATA | None | N | N |
| AT+CEER | +WIND: 4 | Y | N |
| AT+VTD | None | N | N |
| AT+VTS | None | N | N |
| ATDL | None | N | Y |
| AT%D | None | N | N |
| ATSO | None | N | N |
| AT+CICB | None | N | N |
| AT+CSNS | None | N | N |
| AT+VGR | None | N | N |
| AT+VGT | None | N | N |
| AT+CMUT | None | N | N |
| AT+SPEAKER | None | N | N |
| AT+ECHO | None | N | N |
| AT+SIDET | None | N | N |
| AT+VIP | None | N | N |
| AT+DUI | PIN | N | N |
| AT+HUI | PIN | N | N |
| AT+RUI | PIN | N | N |

26.3 Network service commands

| AT commands | Conditions | SIM dependence | Intermediate |
|-------------|------------|----------------|--------------|
| AT+CSQ | None | N | N |
| AT+COPS | +WIND: 4 | Y | N |
| AT+CREG | None | N | Y |
| AT+WOPN | None | N | N |
| AT+CPOL | +WIND: 7 | Y | Y |

26.4 Security commands

| AT commands | Conditions | SIM dependence | Intermediate |
|-------------|-------------------|----------------|--------------|
| AT+CPIN | +WIND: 1 | Y | N |
| AT+CPIN2 | after PIN entered | Y | N |
| AT+CPINC | +WIND: 1 | Y | N |
| AT+CLCK | +WIND: 4 | Y | N |
| AT+CPWD | +WIND: 4 | Y | N |

26.5 Phonebook commands

| AT commands | Conditions | SIM dependence | Intermediate |
|-------------|------------|----------------|--------------|
| AT+CPBS | +WIND: 4 | Y | N |
| AT+CPBR | +WIND: 4 | Y | Y |
| AT+CPBF | +WIND: 4 | Y | Y |
| AT+CPBW | +WIND: 4 | Y | N |
| AT+CPBP | +WIND: 4 | Y | Y |
| AT+CPBN | +WIND: 4 | Y | Y |
| AT+CNUM | +WIND: 4 | Y | N |
| AT+WAIP | None | N | N |
| AT+CSVM | +WIND: 4 | N | N |

26.6 Short Messages commands

| AT commands | Conditions | SIM dependence | Intermediate |
|-------------|------------|----------------|--------------|
| AT+CSMS | +WIND: 4 | Y | N |
| AT+CNMA | +WIND: 4 | Y | N |
| AT+CPMS | +WIND: 4 | Y | N |
| AT+CMGF | +WIND: 4 | Y | N |
| AT+CSAS | | Y | N |
| AT+CRES | | Y | N |
| AT+CSDH | +WIND: 4 | Y | N |
| AT+CNMI | +WIND: 4 | Y | N |
| AT+CMGR | +WIND: 4 | Y | Y |
| AT+CMGL | +WIND: 4 | Y | Y |
| AT+CMGS | +WIND: 4 | Y | N |
| AT+CMGW | +WIND: 4 | Y | Y |
| AT+CMSS | +WIND: 4 | Y | N |
| AT+CSMP | +WIND: 4 | Y | N |
| AT+CMGD | +WIND: 4 | Y | N |
| AT+CSCA | | Y | N |
| AT+CSCB | +WIND: 4 | Y | N |
| AT+WCBM | +WIND: 4 | Y | N |
| AT+WMSC | +WIND: 4 | Y | Y |

| | | | |
|---------|----------|---|---|
| AT+WMGO | +WIND: 4 | Y | N |
| AT+WUSS | None | N | N |

26.7 Supplementary Services commands

| AT commands | Conditions | SIM dependence | Intermediate |
|-------------|------------|----------------|--------------|
| AT+CCFC | +WIND: 4 | Y | N |
| AT+CLCK | +WIND: 4 | Y | N |
| AT+CPWD | +WIND: 4 | Y | N |
| AT+CCWA | +WIND: 4 | Y | N |
| AT+CLIR | +WIND: 4 | Y | N |
| AT+CLIP | +WIND: 4 | Y | N |
| AT+COLP | +WIND: 4 | Y | N |
| AT+CAOC | +WIND: 4 | Y | Y |
| AT+CACM | +WIND: 4 | Y | N |
| AT+CAMM | +WIND: 4 | Y | N |
| AT+CPUC | +WIND: 4 | Y | N |
| AT+CHLD | +WIND: 4 | Y | N |
| AT+CLCC | None | N | N |
| AT+CSSN | None | N | N |
| AT+CUSD | None | N | N |
| AT+CCUG | +WIND: 4 | Y | Y |

26.8 Data commands

| AT commands | Conditions | SIM dependence | Intermediate |
|-------------|------------|----------------|--------------|
| AT+CBST | None | N | N |
| AT+FCLASS | None | N | N |
| AT+CR | None | N | N |
| AT+CRC | None | N | N |
| AT+ILRR | +WIND: 4 | N | N |
| AT+CRLP | None | N | N |
| AT+DOPT | None | N | N |
| AT%C | None | N | N |
| AT+DS | None | N | N |
| AT+DR | None | N | N |
| \N | None | N | N |

26.9 Fax commands

| AT commands | Conditions | SIM dependence | Intermediate |
|-------------|------------|----------------|--------------|
| AT+FTM | None | N | N |
| AT+FRM | None | N | N |
| AT+FTH | None | N | N |
| AT+FRH | None | N | N |
| AT+FTS | None | N | N |
| AT+FRS | None | N | N |

26.10 Class 2 Commands

| AT commands | Conditions | SIM dependence | Intermediate |
|-------------|------------|----------------|--------------|
| AT+FDT | None | N | N |
| AT+FDR | None | N | N |
| AT+FET | None | N | N |
| AT+FPTS | None | N | N |
| AT+FK | None | N | N |
| AT+FBOR | None | N | N |
| AT+FBUF | None | N | N |
| AT+FCQ | None | N | N |
| AT+FCR | None | N | N |
| AT+FDIS | None | N | N |
| AT+FDCC | None | N | N |
| AT+FLID | None | N | N |
| AT+FPHCTO | None | N | N |

26.11 V24-V25 commands

| AT commands | Conditions | SIM dependence | Intermediate |
|-------------|------------|----------------|--------------|
| AT+IPR | None | N | N |
| AT+ICF | None | N | N |
| AT+IFC | None | N | N |
| AT&C | None | N | N |
| AT&D | None | N | N |
| AT&S | None | N | N |
| ATO | +WIND: 4 | N | N |
| ATQ | None | N | N |
| ATV | None | N | N |
| ATZ | None | N | N |
| AT&W | None | N | N |
| AT&T | None | N | N |
| ATE | None | N | N |
| AT&F | None | N | N |
| AT&V | None | N | N |
| ATI | None | N | N |
| AT+WMUX | None | N | N |

26.12 Specific AT commands

| AT commands | Conditions | SIM dependence | Intermediate |
|-------------|-------------------------|--------------------|--------------|
| AT+CCED | None | N | N |
| AT+WIND | None | N | N |
| AT+ADC | None | N | N |
| AT+CMER | None | N | N |
| AT+WLPR | +WIND: 1 | N | N |
| AT+WLPW | +WIND: 1 | N | N |
| AT+WIOR | None | N | N |
| AT+WIOW | None | N | N |
| AT+WIOM | None | N | N |
| AT+WAC | None | N | N |
| AT+Wtone | None | N | N |
| AT+WDTMF | None | N | N |
| AT+WDWL | None | N | N |
| AT+WVR | None | N | N |
| AT+WDR | None | N | N |
| AT+WHWV | None | N | N |
| AT+WDOP | None | N | N |
| AT+WSVG | None | N | N |
| AT+WSTR | None | N | N |
| AT+WSCAN | None | N | N |
| AT+WRIM | None | N | N |
| AT+W32K | None | N | N |
| AT+WCDM | None | N | N |
| AT+WSSW | None | N | N |
| AT+WCCS | +WIND: 4 | N | N |
| AT+WLCK | None (PIN for auto CNL) | N (Y for auto CNL) | N |
| AT+CPHS | +WIND: 4 | Y | N |
| AT+WBCM | None | N | N |
| AT+WFM | None | N | N |
| AT+WCFM | None | N | N |
| AT+WMIR | None | N | N |
| AT+WCDP | None | N | N |
| AT+WMBN | PIN | Y | N |
| AT+WOPEN | None | N | N |
| AT+WRST | None | N | N |
| AT+WSST | None | N | N |
| AT+WLOC | PIN Code | Y | N |
| AT+WBR | None | N | N |
| AT+WBW | None | N | N |
| AT+WBM | None | N | N |

26.13 SIM Toolkit commands

| AT commands | Conditions | SIM dependence | Intermediate |
|-------------|------------|----------------|--------------|
| AT+STSF | None | N | N |
| AT+STIN | +WIND: 4 | Y | N |
| AT+STGI | +WIND: 4 | Y | N |
| AT+STGR | +WIND: 4 | Y | N |

wavecom™

WAVECOM S.A. - 12, boulevard Garibaldi - 92442 Issy-les-Moulineaux Cedex - France - Tel: +33 (0)1 46 29 08 00 - Fax: +33 (0)1 46 29 08 08
WAVECOM, Inc. - 4810 Eastgate Mall - Second floor - San Diego, CA 92121 - USA - Tel: +1 858 362 0101 - Fax: +1 858 558 5485
WAVECOM Asia Pacific Ltd - 5/F Shui On Centre - 6/8 Harbour Road - Hong Kong, PRC - Tel: +852 2824 0254 - Fax: +852 2824 0255

www.wavecom.com